



Anritsu

Discover What's Possible™



MT8852B
Operation
Manual



MT8852B *Bluetooth*[®] Test Set
Operation Manual

Anritsu

Originated by Anritsu Ltd, EMD, Stevenage, U.K.

P/N: 13000-00205
REVISION: A
CREATED February 2006
COPYRIGHT 2006
ANRITSU

Crossed-out Wheeled Bin Symbol

Equipment marked with the Crossed-out Wheeled Bin Symbol complies with the European Parliament and Council Directive 2002/96/EC (the "WEEE Directive") in European Union.

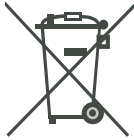

For Products placed on the EU market after August 13, 2005, please contact your local Anritsu representative at the end of the product's useful life to arrange disposal in accordance with your initial contract and the local law.

Warranty

The Anritsu product(s) listed on the title page is (are) warranted against defects in materials and workmanship for one year from the date of shipment. Anritsu's obligation covers repairing or replacing products that prove to be defective during the warranty period. Buyers shall prepay transportation charges for equipment returned to Anritsu for warranty repairs. Obligation is limited to the original purchaser. Anritsu is not liable for consequential damages.

Limitation of Warranty

The foregoing warranty does not apply to Anritsu connectors that have failed due to normal wear. Also, the warranty does not apply to defects resulting from improper or inadequate maintenance by the buyer, unauthorized modification or misuse, or operation outside of the environmental specifications of the product. No other warranty is expressed or implied, and the remedies provided herein are the buyer's sole and exclusive remedies.

Notice about Documentation

Anritsu Limited has prepared this manual for use by Anritsu Limited personnel and customers as a guide for the proper installation and operation of Anritsu Limited equipment and computer programs.

The drawings, specifications, and information contained herein are the property of Anritsu Limited, and any unauthorized use or disclosure of these drawings, specifications, and information is prohibited; they shall not be reproduced, copied, or used in whole or in part as the basis for manufacture or sale of the equipment or software programs without the prior written consent of Anritsu Limited.

Trademark Acknowledgments

The *Bluetooth* word mark and logos are owned by the *Bluetooth* SIG, Inc. and any use of such marks by Anritsu is under license. Other trademarks and trade names are those of their respective owners.

V Connector and K Connector are registered trademarks of Anritsu Limited.

Adobe Acrobat and Acrobat Reader are trademarks of Adobe Systems Incorporated.

Safety Symbols

To prevent the risk of any personnel injury or loss related to equipment malfunction, Anritsu Limited uses the following symbols to indicate safety-related information. For your own safety, please read this information carefully BEFORE operating the equipment.

Symbols Used in This Manual

Danger	Indicates a very dangerous procedure that could result in serious injury or death if not performed properly.
Warning	Indicates a hazardous procedure that could result in serious injury or death if not performed properly.
Caution	Indicates a hazardous procedure or danger that could result in light-to-severe injury, or loss related to equipment malfunction, if proper precautions are not taken.

Safety Symbols Used on Equipment and In Manuals

Some or all of the following five symbols may or may not be used on all Anritsu equipment. In addition, there may be other labels attached to products that are not shown in the diagrams in this manual.

The following safety symbols are used inside or on the equipment near operation locations to provide information about safety items and operation precautions. Ensure that you clearly understand the meanings of the symbols and take the necessary precautions BEFORE operating the equipment.



This symbol indicates a prohibited operation. The prohibited operation is indicated symbolically in or near the barred circle.



This symbol indicates a compulsory safety precaution. The required operation is indicated symbolically in or near the circle.



This symbol indicates warning or caution. The contents are indicated symbolically in or near the triangle.



This symbol indicates a note. The contents are described in the box.



These symbols indicate that the marked part should be recycled.

For Safety



Always refer to the operation manual when working near locations at which the alert mark, shown on the left, is attached. If operation is performed without heeding the advice in the operation manual, there is a risk of personal injury. In addition, the equipment performance may be reduced.

Moreover, this alert mark is sometimes used with other marks and descriptions indicating other dangers.



Or



When supplying AC power to this equipment, connect the accessory 3-pin power cord to a 3-pin grounded power outlet. If a grounded 3-pin outlet is not available, use a conversion adapter and ground the green wire, or connect the frame ground on the rear panel of the equipment to ground. If power is supplied without grounding the equipment, there is a risk of receiving a severe or fatal electric shock.



The operator cannot repair this equipment. DO NOT attempt to remove the equipment covers or to disassemble internal components. Only qualified service technicians with knowledge of electrical fire and shock hazards should service this equipment. There are high-voltage parts in this equipment presenting a risk of severe injury or fatal electric shock to untrained personnel. In addition, there is a risk of damage to precision components.

If this equipment is used in a manner not specified by the manufacturer, the protection provided by the equipment may be impaired.

Declaration of Conformity

Manufacturer's Name: Anritsu Limited MMD-E

Manufacturer's Address: Rutherford Close
Stevenage, Hertfordshire
United Kingdom

declares that the product specified below:

Product Name : Bluetooth Test Set

Model Number : MT8852B

conforms to the requirements of:

EMC Directive 89/336/EEC as amended by the Council Directive 92/31/EEC & 93/68/EEC
Low Voltage Directive 73/23/EEC as amended by the Council Directive 93/68/EEC

Electromagnetic Interference:

Emissions:	EN61326: 1997/A3-2004	Class A
Immunity:	EN 61326: 1997/A2:2001	
	IEC61000-4-2 (ESD)	Class B
	IEC61000-4-3 (EMF)	Class A
	IEC61000-4-4 (BURST)	Class B
	IEC61000-4-5 (SURGE)	Class B
	IEC61000-4-6 (CRF)	Class A
	IEC61000-411 (V dip/short)	Class C
Voltage Harmonics:	EN61000-3-2:2001	Class A
	EN61000-3-3:2002 + Amendment 2001	

Electrical Safety Requirement:

Product Safety: EN61010-1:2001 (Pollution Degree 2)

Anritsu Limited 17th February 2006

Date



Nick Orchiston, Quality Assurance Manager

European Contact: - For Anritsu product EMC & LVD information contact Anritsu Limited, MMD-E,
Rutherford Close, Stevenage Herts, SG1 2EF UK, (FAX +44 (0)1438 740202)

Table of Contents

Warranty.....	i
Limitation of Warranty	i
Notice about Documentation.....	i
Trademark Acknowledgments.....	i
Safety Symbols	ii
For Safety.....	iii
Declaration of Conformity.....	iv
Chapter 1. About this Manual.....	1-1
Purpose and Scope of this Manual	1-2
Your Comments on this Manual	1-2
Software Versions	1-2
Notification of Software Release	1-2
Using this Manual.....	1-3
Associated Documentation.....	1-4
Notation Conventions Used in This Manual	1-4
Chapter 2. MT8852B Overview.....	2-1
What is the MT8852B Bluetooth Test Set?	2-2
Features of the MT8852B.....	2-2
BlueSuite Pro Analysis Software.....	2-4
Options	2-4
Identification Number.....	2-4
Chapter 3. Inspection and Assembly.....	3-1
Initial Inspection.....	3-2
Shipped Items.....	3-2
Storage and Repackaging	3-2
Preparation For Storage.....	3-2
Environmental Requirements	3-2
Preparation for Shipment	3-3
Power Requirements	3-3
AC Line Power	3-3
Fuses	3-3
Grounding	3-3
Operating Environment Requirements	3-4
Rack Mounting.....	3-4
Single Unit Rack Mounting (Option 01).....	3-4
Tools Required.....	3-5
Assembly Procedure	3-5
Side-by-Side Rack Mounting (Option 03)	3-8
Tools Required.....	3-9

Assembly Procedure	3-9
Chapter 4. Connections	4-1
Front Panel Connectors	4-2
Rear Panel Connectors	4-2
Chapter 5. Front Panel Layout and Operation	5-1
Introduction	5-2
Front Panel Controls	5-2
Power-On Procedure	5-4
Hard and Soft Keys	5-4
Hard keys	5-4
Soft Keys	5-5
Choosing Screen Entries	5-5
Entering Data at the Keypad	5-6
Chapter 6. Getting Started	6-1
Preparing the MT8852B for Use	6-2
Selecting a Test Script	6-2
Specifying the EUT Address	6-3
Selecting the Test Mode	6-3
Running a Single Test	6-3
Running a Script in Standard Mode	6-5
Running a Script in Single Payload Mode	6-5
Running a Script in Null Packets Mode	6-6
Chapter 7. Configuring the MT8852B	7-1
Introduction	7-2
Setting up the EUT	7-4
Viewing the EUT Address and User Friendly Name 7-4	
Viewing Supported Features	7-5
Setting Up the EUT Control	7-6
Setting Up Inquiries	7-7
Setting Up Authentication	7-8
Making an Inquiry:	7-9
Setting up the MT8852B	7-10
Displaying the Identity of the MT8852B	7-10
Configuring the System Interfaces	7-11
Setting the Screen Display and Sound	7-12
Setting the Range Hold	7-13
Setting the modulation index	7-14
Setting Up the Link Timeout	7-14
Setting Up the IF Bandwidth Filter	7-14
Setting Up the Signal Generator	7-15

Setting Up the <i>Bluetooth</i> Interferer.....	7-16
Configuring the Rear Panel Outputs	7-17
Performing Continuous Wave Measurement	7-18
Setting Up Test Script Operation.....	7-19
System features.....	7-20
Setting the Link	7-20
Setting Remote Power Control.....	7-21
Updating the Software.....	7-22
Errata 1158	7-23
Service.....	7-23
<i>Chapter 8. Using the Script Menu</i>	<i>8-1</i>
Introduction.....	8-2
Accessing the Script Menu.....	8-3
Locking and Unlocking a Script.....	8-4
Changing the Password	8-5
Running the Tests	8-6
Setting Up General Script Parameters	8-7
Test control delay.....	8-8
Test Pause.....	8-8
EUT Settings on Connection.....	8-8
Setting the Path Offset.....	8-9
Creating or Editing a Path Offset Table	8-10
Testing in Standard Script Mode	8-12
Output Power Test (Standard Mode).....	8-12
Power Control Test (Standard Mode)	8-15
Initial Carrier Test (Standard Mode).....	8-18
Carrier Drift Test (Standard Mode).....	8-21
Single Slot Sensitivity Test (Standard Mode).....	8-24
Multi Slot Sensitivity Test (Standard Mode)	8-27
Modulation Index Test (Standard Mode).....	8-30
Maximum Input Power Test (Standard Mode)	8-33
Relative Tx Power Test (Standard Mode)	8-35
Carrier & Modulation Test (Standard Mode).....	8-37
Differential Phase Test (Standard Mode).....	8-39
EDR Sensitivity Test (Standard Mode)	8-40
EDR BER Floor Test (Standard Mode).....	8-42
EDR Max Input Test (Standard Mode).....	8-44
Testing in Single Payload Script Mode.....	8-46
Output Power Test (Single Payload Mode).....	8-46
Power control test (single payload mode).....	8-46
Initial Carrier Test (Single Payload Mode)	8-47
Carrier Drift Test (Single Payload Mode).....	8-48

Single Slot Sensitivity Test (Single Payload Mode).....	8-49
Multi-Slot Sensitivity Test (Single Payload Mode).....	8-50
Modulation Index Test (Single Payload Mode).....	8-51
Maximum input power test (single payload mode).....	8-51
Entering the BT Address of the EUT	8-52
Viewing Test Results	8-53
Output Power Test Results.....	8-53
Power Control Test Results.....	8-54
Initial Carrier Test Results	8-55
Carrier Drift Test Results.....	8-56
Single Slot Sensitivity Results	8-58
Multi Sensitivity Test Results.....	8-60
Modulation Index Test Results	8-62
Maximum Input Power Test Results.....	8-63
Relative Tx Power Test Results	8-65
Carrier & Modulation Test Results	8-66
Differential Phase Test Results	8-68
EDR Sensitivity Test Results.....	8-69
EDR BER Floor Test Results	8-71
EDR Maximum Input Level Test Results.....	8-72
Chapter 9. Audio Measurements	9-1
Testing the EUT's Audio Performance Using Remote Loopback on the MT8852B ...	9-2
Testing the Audio Performance of the EUT Transmit Path.....	9-5
Testing the Audio Performance of the EUT Receive Path.....	9-6
Putting the EUT into Remote Loopback	9-7
Using Audio Measurements with AFH	9-8
Chapter 10. Adaptive Frequency Hopping (Option 15).....	10-1
The <i>Bluetooth</i> 1.2 Specification	10-2
Overview of Adaptive Frequency Hopping (AFH).....	10-2
AFH Processing	10-4
AFH in the <i>Bluetooth</i> 1.2 Specification	10-5
MT8852B Implementation of AFH	10-5
Installing the AFH Option	10-6
Configuring the MT8852B for AFH Testing.....	10-6
Assessing AFH from Channel Use vs Time Information.....	10-7
Assessing AFH from FER vs Time Information	10-8
Assessing AFH using Audio Measurements.....	10-9
Chapter 11. IQ Data Output (Option 17).....	11-1
EDR Measurements.....	11-3
Relative Transmit Power (TP/TRM/CA/10C).....	11-3
Carrier Frequency Stability (TP/TRM/CA/11C)	11-3

Modulation Accuracy.....	11-3
Differential Phase Encoding (TP/TRM/CA/12C)	11-3
Guard Interval	11-3
Saving Results.....	11-3
Handling Results	11-5
Generating a Power Burst Profile Graph	11-5
Generating Graphs from IQ Data.....	11-5
<i>Appendix A. Top-line Messages</i>	<i>A-1</i>
Introduction.....	A-1
Message Types	A-1
Message Priorities	A-2
Error Codes	A-3
HCI and Communication List of Error Codes	A-8
<i>Bluetooth</i> Specification 1.1 Devices.....	A-8
<i>Bluetooth</i> Specification 2.0 Devices.....	A-9
Internal HCI and Communication List of Error Codes	A-10
<i>Appendix B. Terminology Glossary</i>	<i>B-1</i>
<i>Appendix C. Preset Values</i>	<i>C-1</i>
<i>Appendix D. Specification</i>	<i>D-1</i>
Transmitter Tests.....	D-1
Receiver Tests.....	D-2
Output Power.....	D-3
Power Control.....	D-4
Modulation Characteristics	D-5
Initial Carrier Frequency Tolerance	D-6
Carrier Frequency Drift.....	D-7
Relative Tx Power	D-8
Carrier Frequency Stability and Modulation Accuracy	D-9
Differential Phase Encoding	D-10
Sensitivity - Single Slot Packets.....	D-11
Sensitivity - Multi-Slot Packets	D-12
Maximum Input Level	D-13
EDR Sensitivity.....	D-14
EDR BER Floor	D-15
EDR Maximum Input	D-16
MT8852B Signal Generator.....	D-17
Frequency	D-17
Level.....	D-17
Modulation.....	D-18
MT8852B Measuring Receiver.....	D-19

Frequency.....	D-19
Level.....	D-19
Modulation.....	D-19
EUT Control Interface.....	D-19
Audio Specifications.....	D-20
AFH (Option 15).....	D-20
Frequency Standard.....	D-20
Rear Panel Connectors.....	D-20
GPIB.....	D-21
RS 232.....	D-21
Power Requirements.....	D-21
Environmental.....	D-21
Size and Weight.....	D-21
Ordering Information.....	D-22
Included Accessories.....	D-22
Options.....	D-22
<i>Appendix E. Bit and Frame Error Rates.....</i>	<i>E-1</i>
<i>Appendix F. Technical Support.....</i>	<i>F-1</i>
<i>Appendix G. Connector Care and Handling.....</i>	<i>G-1</i>

Chapter 1. About this Manual

This chapter provides:

- An overview of the scope of information covered in this manual and contact address for your comments.
- A summary of, and links to, each of the chapters in the manual.
- A list of associated documentation and resources.
- An explanation of the notation conventions used in this document.

Purpose and Scope of this Manual

This manual provides installation and operation information for the following unit:

- MT8852B *Bluetooth* Test Set

The structure of this manual is designed to reflect the sequence of steps that the user will go through after receiving the unit; from unpacking and initial inspection, through setup, and to testing.

Your Comments on this Manual

Every effort has been made to ensure that this manual is thorough, easy to use, and free from errors. However, to ensure continued improvement, we would welcome your comments on this, or any other Anritsu document.

Please contact us at the address below if you have any comments, good or bad, find any errors or omissions, or have any suggestions on how our documentation could be improved further.

bluetooth.support@eu.anritsu.com

Your comments will be logged and reviewed, and whenever possible, will be reflected in a subsequent release of the document.

Software Versions

This manual provides details of the operation and functionality of the following software versions:

MT8852B: 4.00

Some of the features documented in this manual may not be available to users of preliminary software releases prior to 4.00. Check the version of software you are using by following the procedure below.

1. Power up the unit and press the **Config** hard key.
2. Select "MT8852B" and press the **Sel** key.
3. Select "Identity" and press the **Sel** key.
4. Check the number that displays to the right of "Version".

Notification of Software Release

The MT8852B software is periodically updated as new features are added to meet market demands. To receive automatic notification of software releases, send a blank e-mail with the subject heading of "MT8852B Software Notification Request" to bluetooth.support@eu.anritsu.com. You will receive an e-mail informing you that the new software is available for download from the site identified.

Using this Manual

Users are advised to read through this manual in its entirety before operating the instrument. The manual should be kept with the unit for reference purposes thereafter.

A brief summary of each of the chapters is given below. If you are viewing the electronic version of this manual you can click on the chapter headings below to jump to the chapter in question.

Chapter 1	About this Manual Details of the manual itself, how it is structured, and how to use it.
Chapter 2	MT8852B Overview An overview of the product, its features and options.
Chapter 3	Inspection and Assembly How to unpack, inspect and ready the instrument for measurement.
Chapter 4	Connections A description of the physical connections to the MT8852B <i>Bluetooth</i> Test Set on both the front and rear panels.
Chapter 5	Front Panel Layout and Operation Detailed illustrations and explanations of front panel operation.
Chapter 6	Getting Started Procedural explanations of preparing the MT8852B for use, selecting a test script, specifying the EUT address, and selecting the test mode.
Chapter 7.	Configuring the MT8852B Explanations of the configuration settings accessed by pressing the  hard key.
Chapter 8	Using the Script Menu Details of the test script settings and an overview of each of the standard and EDR measurements available.
Chapter 9	Audio Measurements An explanation of how the MT8852B can be used to perform audio measurements by establishing a SCO link between the MT8852B and the EUT.
Chapter 10	Adaptive Frequency Hopping (Option 15) Details of the AFH option for the MT8852B.
Chapter 11	IQ Data Output (Option 17) An explanation of how the IQ data output software option can be used to capture and view received packets for more detailed analysis.
Appendix A	Top-line Messages A list and explanation of messages that may display on the top line of the LCD.

Appendix B	Terminology Glossary	A glossary of acronyms commonly used in this manual or in technical documentation associated with <i>Bluetooth</i> .
Appendix C	Preset Values	Details of the default settings for each of the major setting items.
Appendix D	Specification	The complete instrument specification.
Appendix E	Bit and Frame Error Rates	A flow diagram illustrating the decision processing performed by the MT8852B in determining bit and frame error rates.
Appendix F	Technical Support	How to contact Anritsu if you require technical assistance.
Appendix G	Connector Care and Handling	Precautions to follow when handling or connecting cables.

Associated Documentation

In addition to this manual, the following document is also available on the CD shipped with the MT8852B *Bluetooth* Test Set.

Part number	Document
13000-00110	MT8850A/MT8852A/MT8852B <i>Bluetooth</i> Test Set Remote Programming Manual

The pdf file listed above can be viewed using Adobe Reader™, a freeware program that can be downloaded from <http://www.adobe.com/>.

Notation Conventions Used in This Manual

Config	This style is used for the hard keys on the unit itself.
[Setup]	Soft keys that display on the screen are enclosed in square brackets. Pressing a soft key provides access to menu options, toggles selections and allows data entry.
“Output power”	Items or text that display within the main body of the screen are enclosed in quotation marks.

Chapter 2. MT8852B Overview

This chapter provides:

- An overview of the MT8852B and its features.
- Details of available options and accessories.

What is the MT8852B *Bluetooth* Test Set?



Building on the strengths of the MT8850/52A, the MT8852B is a complete *Bluetooth* test solution that meets the requirements of testing *Bluetooth* enabled devices compliant with the 1.1, 1.2, and 2.0 (EDR) specifications.

Features of the MT8852B

- Supports both standard and Enhanced Data Rate (EDR) measurements.

The MT8852B can be used to perform eight standard measurements and the six EDR measurements defined in the *Bluetooth* EDR Radio layer test specification.

- Three test modes

Standard mode in which the MT8852B uses full Test Mode signalling and all the defined test controls to test the EUT in the fastest and most efficient way possible.

Single payload mode in which Test Mode signalling is performed in a very restricted manner. The customer can define the packet length, packet payload, select loopback or TX mode and hopping on or off.

Null packet mode enables measurements to be made on EUTs that do not have test mode support, by performing a limited subset of measurements on packets without payloads. None of these measurements are performed in accordance with the *Bluetooth* test specifications.

- Fast

Keep your production lines flowing with the rapid “Quick Test” measurement script.

- One touch testing

Once the MT8852B has been configured, each device is tested with a single keystroke. Press Run to initiate a link, activate Test Mode, perform all specified measurements (standard and EDR), and output the results.

- Authoritative

Under standard operation, tests are made exactly as defined in the *Bluetooth* RF Test Specification. All measurements are traceable to National Standards so you can be totally confident in both your production testing and design proving.

- Reference *Bluetooth* transceiver

A custom design transceiver offers <1 kHz frequency accuracy at the start of any packet and full compliance with the requirements for the “Dirty Transmitter” for true receiver sensitivity measurements. In addition to the standard dirty transmitter table, you can define customized stress conditions with user settable values of Carrier Frequency Offset, Modulation Index, Symbol Timing Error and simulated carrier frequency drift.

- Remote control

Both GPIB and RS232 interfaces are offered as standard. Creating test programs has been simplified by the ability to send single commands for initiating a test and returning all results in a single string.

- Small size and weight

MT8852B takes up minimal space in your test system thanks to its half rack size and low weight.

- Editable tests

Define your own test scripts to customize the test measurements to your specific requirements. Each test can be enabled or disabled and within any test, parameters such as hopping can be enabled or disabled, the number of measured packets defined, and the specific frequencies of testing set up.

- Ease of operation

The BT address can be acquired by entering it manually at the keyboard, by performing an inquiry, or by means of an RS232 or USB HCI link. Once the EUT BT address is known a *Bluetooth* link is established using Paging.

- Field upgradeable

The *Bluetooth* protocol stack is held in FPGA so that future versions of the core *Bluetooth* specification can be installed locally. The instruments main program is held in flash memory so product enhancements are also field downloadable.

- Audio testing

The MT8852B *Bluetooth* Test Set can be used to perform audio measurements by establishing a Synchronous Connection Oriented (SCO) link between the MT8852B and the EUT.

- Adaptive Frequency Hopping (AFH) testing (option 15)

The MT8852B *Bluetooth* Test Set can be used to verify that EUT is correctly identifying and blocking channels being used by an interfering signal.

BlueSuite Pro Analysis Software

A BlueSuite software package gives PC control of the MT8852B for advanced design proving measurements on *Bluetooth* radios. Use BlueSuite to view burst power profiles, modulation eye diagrams, display graphs of the output power of the 79 frequencies and many other advanced diagnostic tools.

Options

Item	Part number
Rack Mount, single instrument	MT8850A-01
Rack Mount, side-by-side	MT8850A-03
<i>Bluetooth</i> antenna and adapter	MT8850A-10
Headset and Handsfree profile emulator software	MT8852A-14P/U
Adaptive Frequency Hopping	MT8852A-15
Headset and Handsfree support	MT8852A-16
IQ data output	MT8850A-17
Spare EUT/RS232 cable	MT8850A-20
Spare EUT/USB cable	MT8850A-21
Extra Operation and Programming Manual	MT8850A-30
Soft carry case with shoulder strap	D41310
BlueSuite Pro software (standard rates only)	
Z540, ISO25 calibration certificate + test data	MT8852B-98
PREMIUM Z540, ISO25 calibration certificate + test data	MT8852B-99

Identification Number

The MT8852B *Bluetooth* Test Set has an ID number affixed to the rear. Use the complete ID number when ordering parts or corresponding with the Anritsu Customer Service department.

Chapter 3. Inspection and Assembly

This chapter provides:

- Details of how to inspect the MT8852B upon delivery.
- A list of shipped items.
- Details of how to store and repack the MT8852B.
- Power and environmental requirements.
- Rack mounting instructions

Initial Inspection

Inspect the shipping container for damage. If the container or cushioning material is damaged, retain until the contents of the shipment have been checked against the packing list and the instrument has been checked for mechanical and electrical operation.

If the Test Set is damaged mechanically, notify your local sales representative or Anritsu Customer Service Center. If either the shipping container is damaged or the cushioning material shows signs of stress, notify the carrier as well as Anritsu. Retain the shipping materials for the carrier's inspection.

Shipped Items

Your MT8852B is shipped with the following items. Check that all listed items are present, and contact Anritsu if they cannot be found.

Item	Quantity
RS232 HCl control interface lead	1
RS232 cable for firmware updates	1
Power cord for destination country	1
Certificate of calibration	1
USB HCl control interface lead	1
3.5 mm jack plug	3
CD containing:-	
MT8852B Operation Manual	1
MT8852B Remote Programming Manual	1
BlueTest2 Operation Manual	1
BlueTest2 software	1
BlueSuite software (standard version)	1

Storage and Repackaging

Follow the instructions in this section if, for any reason, it is necessary to repackage, store, or reship your MT8852B.

Preparation For Storage

Preparing the MT8852B *Bluetooth* Test Set for storage consists of cleaning the instrument and packing it with moisture-absorbing desiccant crystals.

Environmental Requirements

Store the instrument in a temperature-controlled environment that is maintained between -40 and +70° C (-40 to ±158° F), with a maximum humidity of 90% at 40° C (104° F), non-condensing.

Preparation for Shipment

1. To provide maximum protection against damage in transit, the MT8852B should be repackaged in the original shipping container. If this container is no longer available, obtain a corrugated cardboard carton of suitable strength. To allow for cushioning this carton should have inside dimensions of no less than 150 mm (six inches) larger than the instrument dimensions.
2. Wrap the instrument to protect the finish.
3. Cushion the instrument on all sides by tightly packing dunnage or urethane foam between the carton and the instrument. Provide at least three inches of dunnage on all sides.
4. Seal the carton using either shipping tape or an industrial stapler.
5. If the instrument is being returned to Anritsu for service, mark the address of the appropriate Anritsu service center (refer to the address at the back of this manual).

Power Requirements

The MT8852B *Bluetooth* Test Set is operated from AC line power. The MT8852B is intended as an Installation (Overvoltage) Category II, Insulation Category I device.

At power-on, the instrument will perform a brief power-on self test (POST). If a POST error occurs, information and available options will be displayed on the screen. If the POST is successful, the instrument will then go to the top-level script or single test screen that was active when it was powered down.

AC Line Power

The MT8852B can operate on AC input power of 85-264V, 47-63 Hz, 150 VA maximum. The Test Set automatically configures itself for the voltage applied. An internal fuse protects the AC line input.

Fuses

The MT8852B *Bluetooth* Test Set is protected on the AC input by an internally mounted fuse. Only qualified service personnel should change this fuse. Replace only with a fuse of the same type and rating, which is 5 mm x 20 mm, 250V, 2.5A T (T= time lag or slo-blo).

Grounding

The MT8852B *Bluetooth* Test Set must be properly grounded. Failure to ground the instrument could be hazardous to operating personnel. The instrument is supplied with a three-wire power cord.

The instrument is properly grounded when the plug is correctly installed in a grounded receptacle. A grounding terminal is provided on the instrument rear panel.

Operating Environment Requirements

The MT8852B is designed to operate within the temperature range of 5 to 40° C with a maximum humidity of 90% at 40° C, non-condensing. Full accuracy is specified at 5 to 35° C (23 to 95° F).

Although not recommended, operation in temperatures to –20°C is possible. At these temperatures, however, the liquid crystal display may exhibit excessively slow response.

CAUTION The instrument is cooled by a fan at the rear that circulates air around the instrument through the vent holes in the base. The fan and the vent holes should not be blocked.

Rack Mounting

The MT8852B *Bluetooth* Test Set can be ordered with rack mounting hardware that allows the instrument to be mounted into a standard 19-inch equipment rack. There are two rack mount option kits available:

The MT8850A-01 Rack Mount option allows the installation of a single MT8852B in either the left or right side rack position.

The MT8850A-03 Rack Mount option allows side-by-side mounting of two MT8852B Test Sets.

Single Unit Rack Mounting (Option 01)

This section describes the assembly procedure for fitting a single MT8852B *Bluetooth* Test Set into an instrument rack. The MT8852B universal top and bottom covers have removable feet to allow the rack mount kit to be fitted. The procedure involves fitting the support bracket, front plate, base panel, and a rear support bracket to the MT8852B. The MT8852B can then be loaded and secured in the rack position.

Kits Parts List

Anritsu No.	Description	Quantity	Max Torque Setting
50077	Front face plate	1.0	
900-848	M4, kep nut.	2.0	14 lbf.in [158 cNm]
790-319	Speed nut	4.0	
900-345	#4, sst, washer, flat	8.0	
900-821	Decorative screw	4.0	
905-68	M3x8, pos, sst, patchlock, screw, metric, pan head.	8.0	4 lbf.in [45 cNm]
788-575	Snap rivet, plastic	6.0	
C37276	Rack mount, side, bracket	1.0	

C41449	Rear support, bracket, rack mount	1.0	
D41473	Rack mount, support bracket	1.0	
49361	Bracket support, base panel	1.0	
MT8852B	MT8852B fitted with universal top and bottom covers with removable feet.	1.0	

Tools Required

- 1 Small Phillips screwdriver
- 1 Large Phillips screwdriver
- 1 Small Phillips torque screwdriver 0 cNm to 50 cNm.
- 1 Torque socket driver 0 cNm to 200 cNm.
- 1-Foot removal tool (supplied).
- 1 Assembly drawing "MT8852B/01 Rack Mounted left or right option"

Assembly Procedure

1. Remove all feet from the MT8852B using the tools supplied. See diagram and notes on the following pages.
2. Confirm the correct tools are available, the parts listed above are present and the assembly drawing is at hand.
3. Lay the large support bracket D41473 next to the MT8852B *Bluetooth* Test Set as per the assembly drawing. Note if the instrument needs to be mounted on the left side of the rack, simply lay the bracket on the right side. i.e. a mirror image of the assembly drawing.
4. Locate the support bracket on to the four case pillars. Secure with 4 screws 905-68 and 4 washers 900-345. See max. torque setting above. Leave the two rear screws loose to allow alignment, location, and securing of the 6 base plate snap rivets 788-575.
5. Locate the front rack mounting bracket C37276 at the front of the instrument on the other side to the large support bracket with two screws 905-68 and two washers 900-345. See max. torque setting above.
6. Locate the rear rack bracket C41449 at the back of the instrument on the other side to the large support bracket with two screws 905-68 and two washers 900-345. See max. torque setting above.
7. Fit the front face plate 50077 with 2 kep nuts 900-848. See max. torque setting above.
8. Position the base panel 49361 as shown in the drawing, and secure with 6 snap rivets 788-575.
9. Fit the four speed nut 790-319 to the rack in the correct place to allow mounting of the instrument in the rack.
10. Slide the instrument into the rack and secure with 4 decorative screws 900-821.

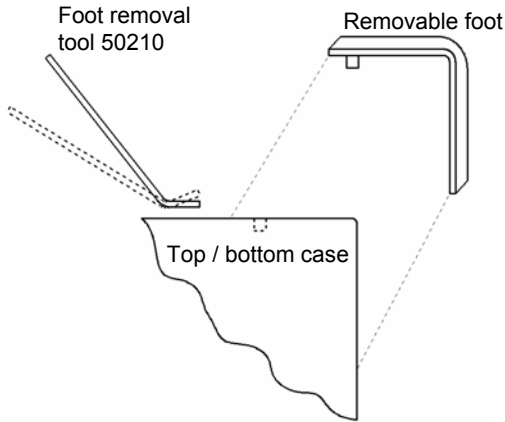

Foot removal:

1. To remove feet. Locate the removal tool into the recess of each foot located on the top and bottom faces of the covers.
2. Once the removal tool has been located in the foot recess, apply gentle pressure downward. This will release the foot.
3. To replace the feet, simply locate the peg into the recess and press down. The foot will now snap on.

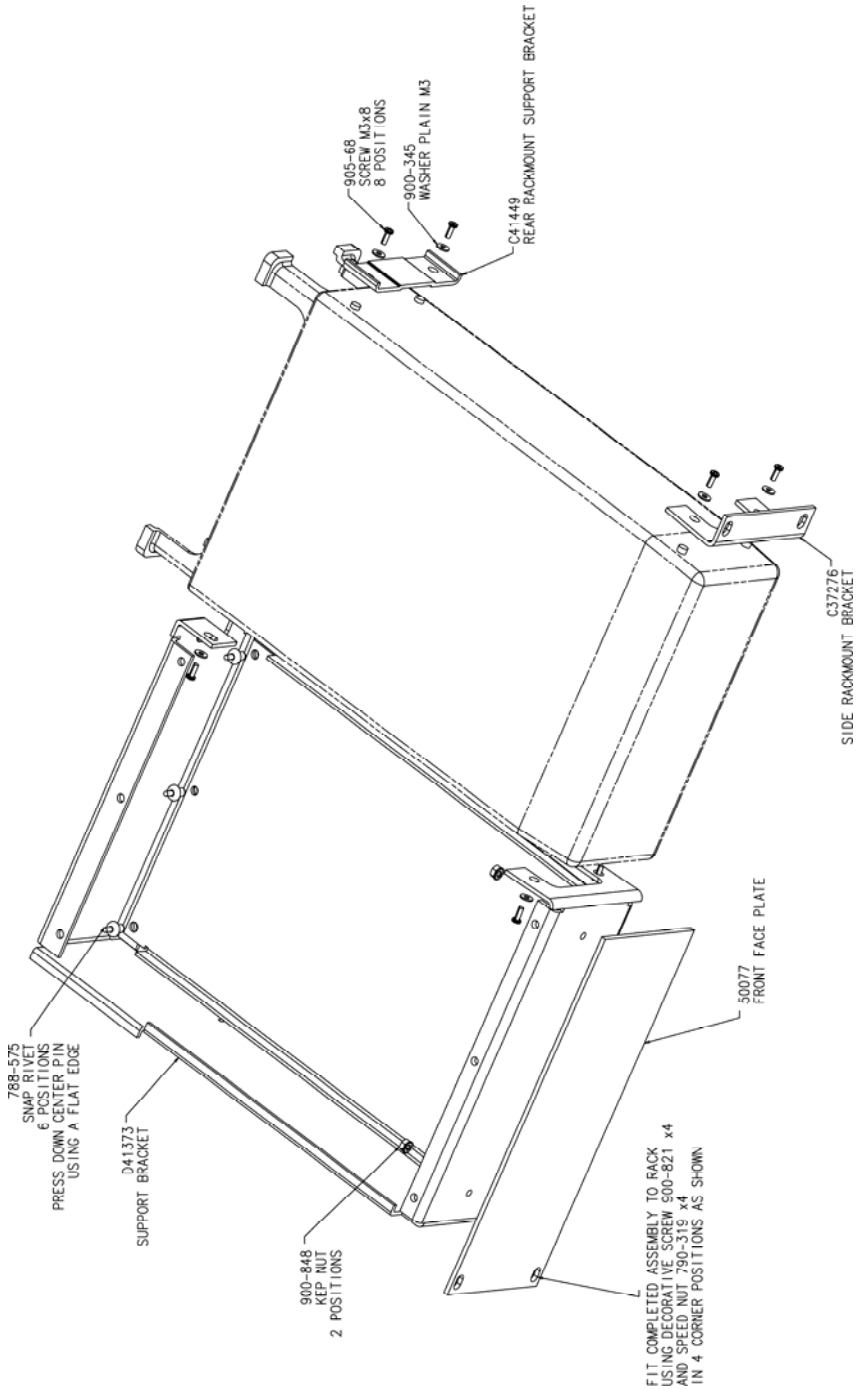

Side-by-Side Rack Mounting (Option 03)

This section describes the assembly procedure for fitting two MT8852B units into a instrument rack. The universal top and bottom covers have removable feet to allow the rack mount kit to be fitted. The procedure involves fitting support brackets and two rear support brackets, one to each unit. The two MT8852B, which are locked together, can then be loaded and secured in the rack position desired.

Kit Parts List

Anritsu No	Description	Quantity	Max.Torque Setting
790-319	Speed Nut	4.0	
900-345	Washer,6-32UNC,Oversize	16.0	
900-821	Decorative Screw	4.0	
905-68	M3X8,POS,SST,Patchlock, Screw, Metric,PAN HD	16.0	4lbf.in [45cNm]
905-69	M3X6,POS,SST,Patchlock, Screw, Metric,FLT HD	4.0	
900-807	Washer,M4 SPLIT	4.0	
900-806	M4X12MM, Screw, PAN HD.	2.0	
905-103	M3.5X8MM,Screw,PAN HD.	2.0	
905-63	M4X10MM, Screw, FLT HD.	4.0	
49415	Rack Mount, Side Bracket	1.0	
49413	Rack Mount, Center Rear Bracket	1.0	
49439	Spacer Plate	2.0	
C37275	Rack Mount,Center, Frt, Bracket	1.0	
C37276	Rack Mount, Side, Bracket	1.0	
C37277	Rack Mount, Center, Bracket	1.0	
C37279	Rack Mount, Center, Bracket	1.0	
C41449	Rear Support, Bracket, Rackmount	2.0	
50210	Foot removal tool	1.0	

Tools Required

- 1 Small Phillips screwdriver
- 1 Large Phillips screwdriver
- 1 Small Phillips torque screwdriver 10cNm to 120cNm.
- 1 Foot removal tool 50210 (supplied).
- 1 Assembly drawing "ML2400/03 SIDE BY SIDE OPTION"

Assembly Procedure

1. Remove all feet using tool supplied. See diagram on the following page.
2. Confirm the correct tools are available, the parts listed above are present and the assembly drawing is at hand.
3. On the two sides of the MT8852B to be joined together, fit the two rear brackets 49413, C37279, and two front brackets C37275, C37277 using 8 screws 905-68 and 8 washers 900-345. See max. torque setting above.
4. Slide the two units together and secure using 4 counter sink screws 905-69.
5. Locate the two front rack brackets C37276 and 49415 at the front of each unit, one on each side with four screws 905-68 and four washers 900-345. See max. torque setting above.
6. Locate the two rear rack brackets C41449 at the back of each unit, one on each side with four screws 905-68 and four washers 900-345. See max. torque setting above.
7. Fit the four speed nuts 790-319 to the rack in the correct place to allow mounting of the two units in the rack.
8. Slide the two units into the rack and secure with 4 decorative screws 900-821.

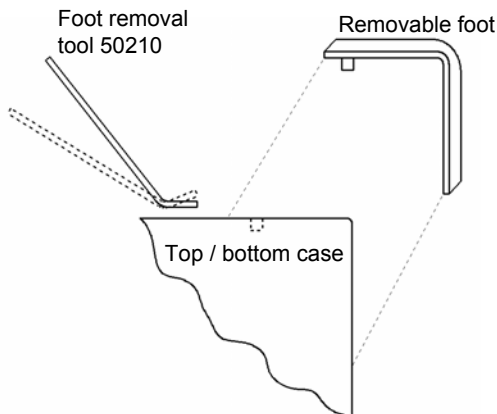

Foot Removal:

1. To remove feet. Locate the removal tool into the recess of each foot located on the top and bottom faces of the covers.
2. Once the removal tool has been located in the foot recess, apply gentle pressure downward. This will release the foot.
3. To replace the feet, simply locate the peg into the recess and press down. The foot will now snap on.

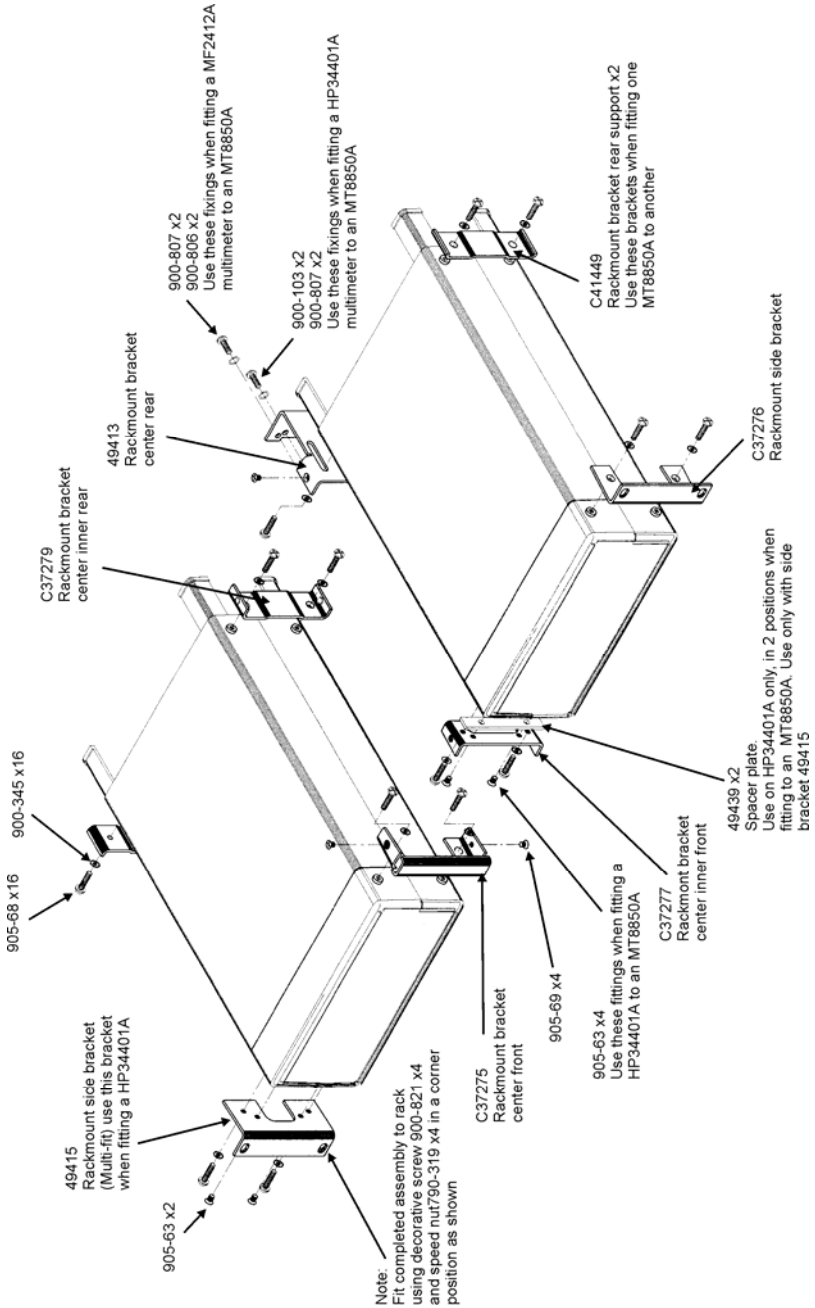

Chapter 4. Connections

This chapter provides:

- A description of the physical connections to the MT8852B *Bluetooth* Test Set on both the front and rear panels.

Front Panel Connectors

The front panel connectors are illustrated below.

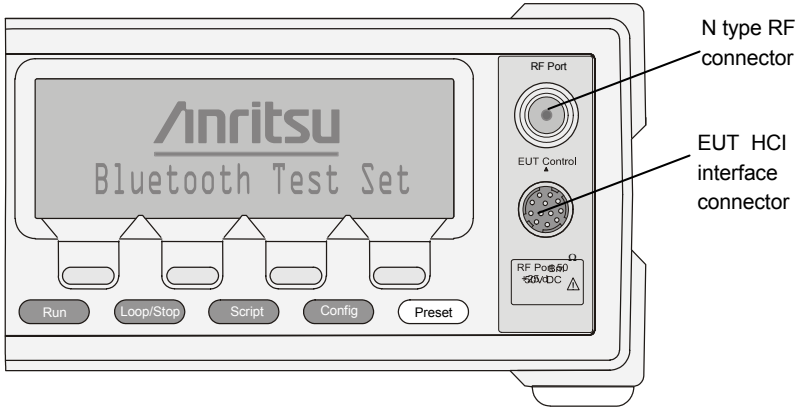

Rear Panel Connectors

The rear panel connectors are illustrated and described in the diagram on the next page.

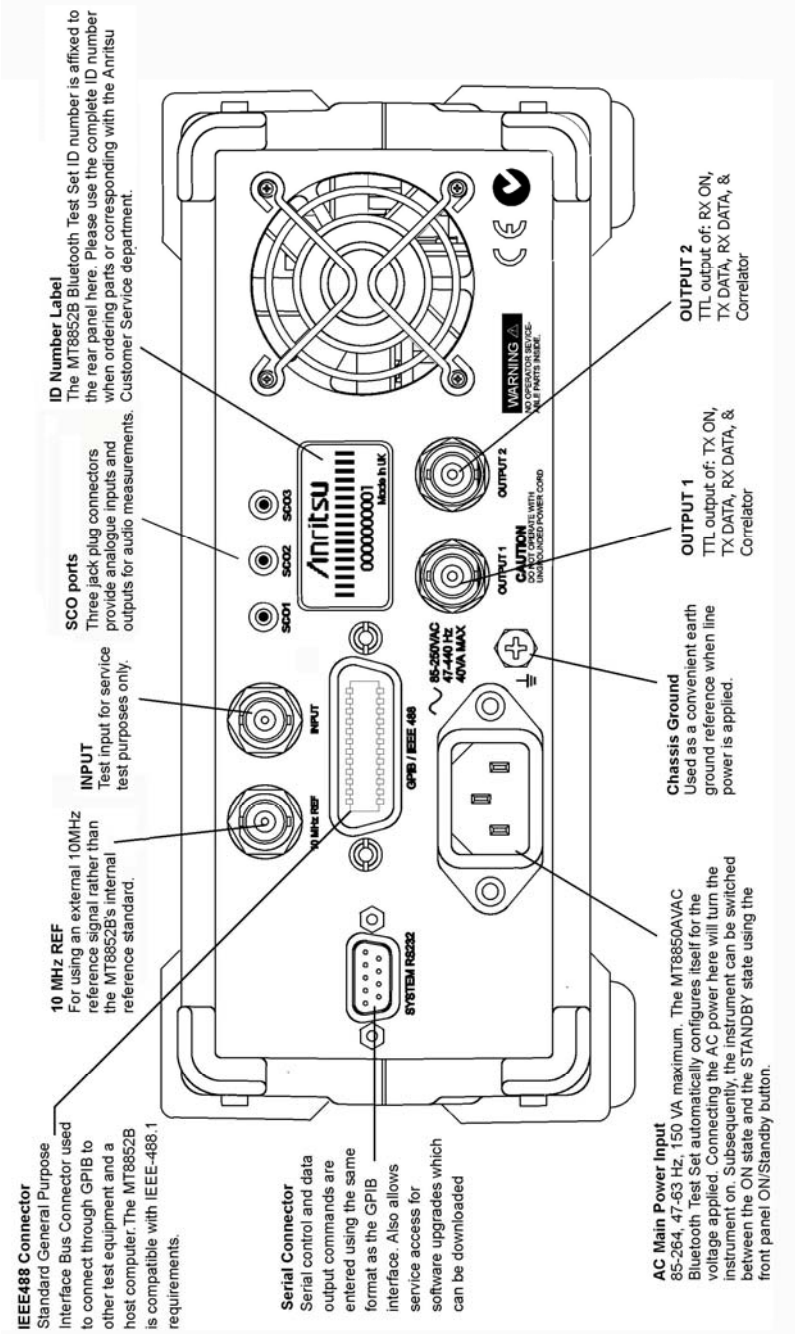

Chapter 5. Front Panel Layout and Operation

This chapter provides:

- Details of the controls on the front of the MT8852B.
- An explanation of the power-on procedure.
- An explanation of how to use keypad to enter the required setting or value.

Introduction

The MT8852B *Bluetooth* Test Set is controlled from the front panel using the hard and soft keys. This chapter explains the power-on procedure and the features and functions of each of the menus.

Front Panel Controls

The front panel controls are shown and described in the diagram on the next page. The following sections provide more detailed explanations of the Menus and soft keys.

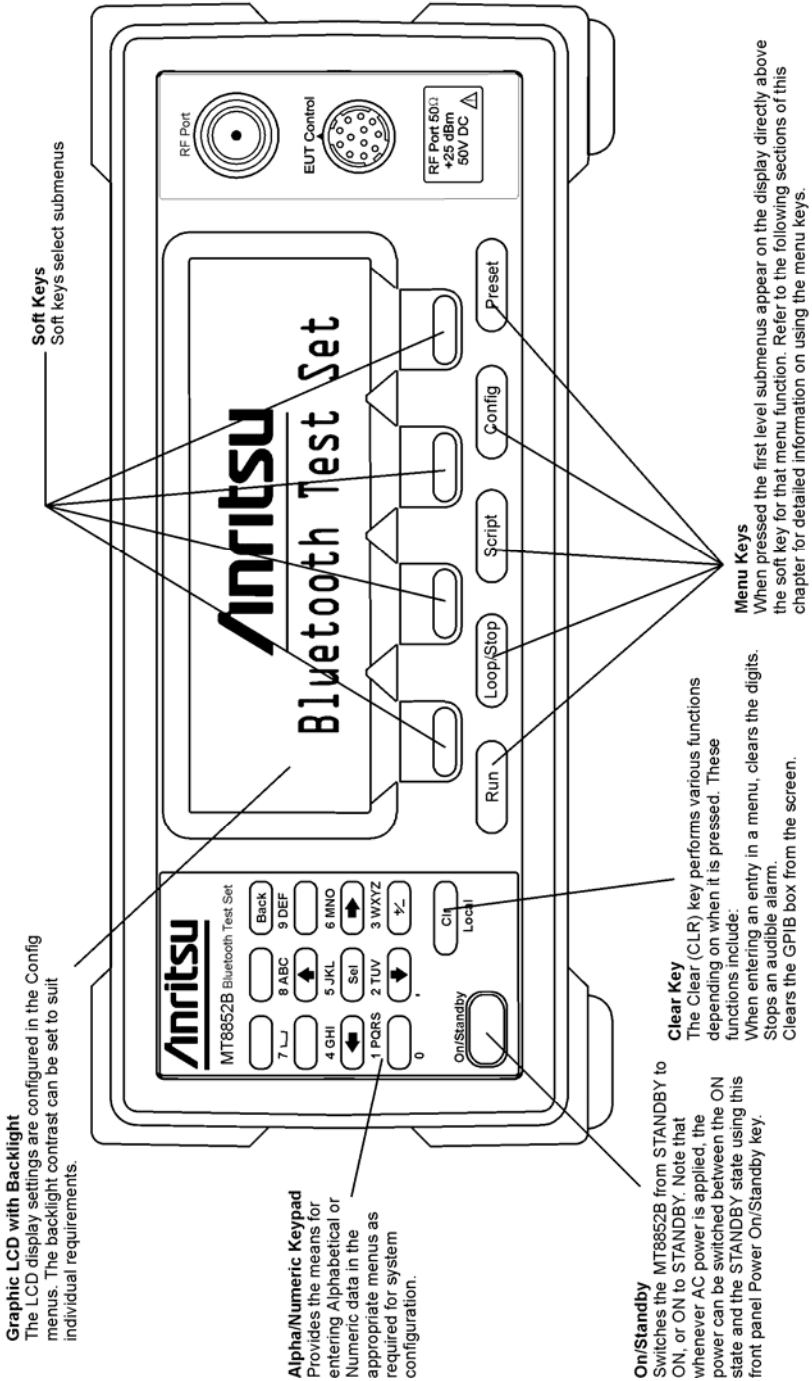

Power-On Procedure

With the MT8852B Bluetooth Test Set connected to the power supply, press the On/Standby button.

The MT8852B performs a brief power-on self test (POST). After the POST, the instrument displays the Script menu or the single test screen that was active when it was powered down. If a POST error occurs, information and available options will be displayed on the screen.

During the power-on self test, only failures and warnings will be displayed on the front panel. If all the tests pass successfully, no self-test information is displayed.

Hard and Soft Keys

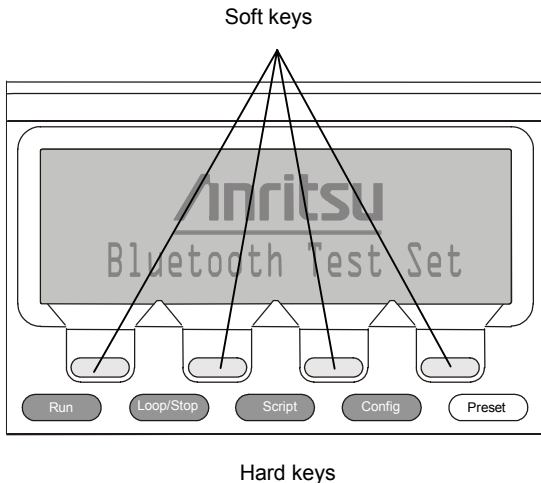

Hard keys

- Run** Executes the chosen script or test once.
- Loop/Stop** Executes the chosen script or test the number of times defined in the Script setup procedure. If this key is pressed again while the tests are running, the tests will stop.
- Script** Allows the user to select and edit the various parameters of the script.
- Config** Gives the user access to the MT8852B parameters. The parameters and associated procedures are described in the "Configuring the MT8852B" chapter.
- Preset** Presets the instrument to a predefined state. See Appendix C *Preset Values* for details.
- CLR** Clears the last character entered or aborts an operation.
- Sel** Used to select or enter your chosen function.
- Back** Returns the display to the previous screen or level.

Soft Keys

There are four soft key positions on the bottom line of the LCD.

The text corresponding to a soft key appears only when that soft key function is active. The soft keys perform two specific functions:

- They are used to directly access another menu or additional screen.
- They are used to initiate an action such as “Enter”.

Choosing Screen Entries

The four arrow keys on the keypad can be used to move the cursors to the screen entry that you want to select or edit.

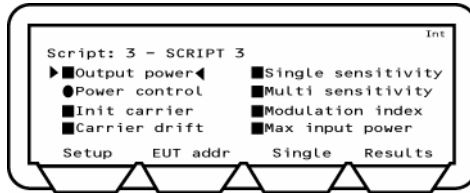

For each press the cursors will move in the chosen direction. For vertical movement, when the cursors reaches the top or the bottom, they will start again at the opposite end.

When the cursor is at the item that you want to select or modify, press the **Sel** key.

Entering Data at the Keypad

The alphanumeric keypad is used to enter data such as hexadecimal addresses and operates in the following manner. For each consecutive press of a key, the display will show the next character in sequence associated with that key. When you press a different key the last value selected will be entered and the cursor moves to the next position. If you want to enter two or more characters from the same key, you must press the [**Forward**] soft key to enter the value and move on to the next entry position.

For example, to enter the address 000091E082A5, you would need to press the following keys in the sequence shown:

0 [**Forward**]

0 [**Forward**]

0 [**Forward**]

0

9

1

9 9 9

0

8

2

8 8

5

Chapter 6. Getting Started

This chapter provides:

- Explanation of how to prepare the MT8852B for use.
- How to select a test script.
- How to specify the EUT address.
- How to select the test mode.

Before you can run a test the EUT must be initialised so that it is page scanning with test mode enabled.

Preparing the MT8852B for Use

1. Connect the RF port on the front panel of the MT8852B to the EUT or to the *Bluetooth* antenna.
2. If you wish to use the MT8852B to initialise the EUT, connect the supplied cable from the EUT control connector on the front panel of the MT8852B to the EUT RS232 HCI interface.

Note: The USB device should only be connected when the MT8852B has been fully powered.

3. Ensure the MT8852B is connected to the mains power supply.
4. Press the [On/Standby] button on the front panel of the MT8852B.

The MT8852B performs a brief power-on self test (POST). After the POST, the instrument displays the Script menu or the single test screen that was active when it was powered down. If a POST error occurs, information and available options will be displayed on the screen.

5. Press the **Preset** hard key to restore the default settings. See Appendix C, *Preset Values* for details.

Selecting a Test Script

1. Press the **Script** hard key to display the screen shown below.

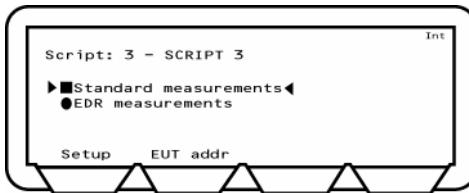

2. Move the cursor to the Script number and either:

Press the **Sel** key, enter a script number from the keypad and press the **[Enter]** soft key. Alternatively, press the **[List]** soft key, move the cursor to the desired script and press the **Sel** key.

Specifying the EUT Address

1. Move the cursor into the measurement area of the screen.
2. Press the **[EUT addr]** soft key and select manual, RS232, inquiry, or USB.
3. Press the **Run** hard key to run the test script once or:
 Press the **Loop/Stop** hard key to run the test script according to the configuration settings of the MT8852B.
 Press the **[Abort]** soft key to terminate the script immediately. Press the **Loop/Stop** hard key again to stop continuous script running.
4. Press the **[Setup]** soft key and then press the **[Results]** soft key to view the results obtained from the tests.

Selecting the Test Mode

There are three test modes available; standard, single payload, and null packet, each of which is explained in detail later in this chapter. In all cases, the user can select between each of the modes on a script-by-script basis as detailed below.

1. Move the cursor to the script number and press the **[Setup]** soft key.
2. Check that the cursor is at the “Script mode” item and if so, press the **Sel** key to toggle between the three test mode settings. For standard mode and null packet mode, no further settings are required on this screen, however if single payload mode is selected, an additional line is displayed on the same screen to allow the user to define the packet type and payload. (Refer to the explanation and table of required settings later in this chapter.)

Running a Single Test

The single test functionality can be used in any of the scripts to allow the user to run only the test that has been selected rather than all of the tests that are available in that script.

1. Press the **Script** hard key.
2. Select either the standard or EDR measurement options and press the **[Setup]** soft key to display a list of all associated tests as shown below.

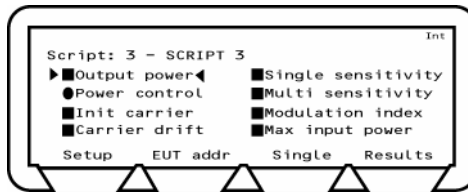

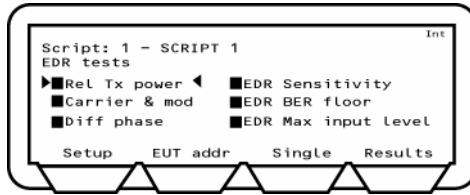

3. Move the cursor to the Script number and either:

Press the **[Sel]** key, enter a script number from the keypad and press the **[Enter]** soft key.

or:

Press the **[List]** soft key, move the cursor to the desired script and press the **[Sel]** key.

4. Move the cursor back into the measurement area of the screen.
5. Press the **[EUT addr]** soft key and select manual, inquiry, RS232, or USB.
6. Press **[Back]** and select the test to be performed.
7. Press the **[Single]** soft key.

The relevant results screen for the test is displayed.

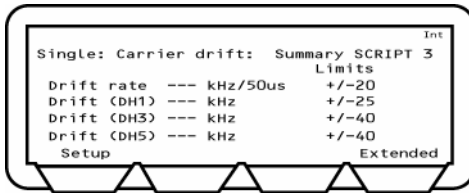

From this screen you can set up the test and save this setup information to be used for future tests.

8. Press the **[Setup]** soft key to go the setup screen for the chosen test.

Note: Scripts 1 and 2 are predefined and cannot be altered.

9. Press the **[Save]** soft key to save the setup information.

10. Press the **[Run]** hard key to run the test once or:

Press the **[Loop/Stop]** hard key to run the test script according to the configuration settings of the MT8852B.

Press the **[Abort]** soft key to terminate the script immediately. Press the **[Loop/Stop]** hard key again to stop continuous script running.

11. The test results are displayed.

Running a Script in Standard Mode

In Standard mode, the MT8852B uses full Test Mode signalling and all the defined test controls to test the EUT in the fastest and most efficient way possible. Standard mode is the default mode setting, although it should be noted that for devices with only a limited implementation of test mode functionality, operation in standard mode may result in the EUT dropping the link or failing to respond to commands from the MT8852B. In this case, select single payload or null packet operation.

Running a Script in Single Payload Mode

Single payload mode uses Test Mode signalling but in a very restricted manner. This is ideal when the test device does not yet have a full Test Mode implemented, and the repetitive signalling in standard mode may cause it to fail or drop the link. When the user selects to run a script in single payload mode, a message to this effect displays on the uppermost line of every page to remind the user that a mode other than standard is currently selected.

In this mode, the user can define the packet length, packet payload, and set loopback or TX mode and hopping to on or off. The MT8852B then sends a single test control to put the EUT into the specified state, and no further test controls are sent. When the customer views the measurement screens, only measurements that can be made on the selected packets are presented.

If single payload mode is selected, an additional “single payload” line displays on the screen.

1. Move the cursor to the script number and press [Setup].
2. Move the cursor to the “Script mode” item and press the **Sel** key to set this item to “SINGLE PAYLOAD”.
3. Move the cursor to the word “Edit” (that displays to the right of “single payload”) and press the **Sel** key. The user now has two pages of configuration for the single payload of their choice.
4. When the payload selection is complete press **Script** to return to the main measurement screen. Only measurements supported by the selected payload are available. Invalid measurements have oval symbols beside them.

The table below shows the single payload settings required to enable each of the tests.

	Test control	Payload	Packet type	Hopping	Dirty
Output power	TX or Loopback	Any	Any	On or Off	Off
Power control	Not supported in single payload mode.				
Init carrier	TX or Loopback	Any	Any	On or Off	Off
Carrier drift	TX or Loopback	10101010 only	Any	On or Off	Off
Single sensitivity	Loopback only	PRBS9 only	DH1 only	On or Off	On or Off
Multi sensitivity	Loopback only	PRBS9 only	DH3 or DH5	On or Off	On or Off
Modulation index	TX or Loopback	10101010 or 11110000	Any	Off	Off
Max input power	Not supported in single payload mode.				
Rel Tx power	Not supported in single payload mode.				
Carrier & mod	Not supported in single payload mode.				
Diff phase	Not supported in single payload mode.				
EDR sensitivity	Not supported in single payload mode.				
EDR BER floor	Not supported in single payload mode.				
EDR max input	Not supported in single payload mode.				

Running a Script in Null Packets Mode

This mode is used to enable indicative measurements to be made on EUTs that have no test mode support. In this mode the MT8852B does not use Test Mode signalling at all, and makes only a limited subset of measurements on packets without payloads.

Measurements are not performed in accordance with the *Bluetooth* test specification. When the user selects to run a script in null packets mode, a message to this effect displays on the uppermost line of every page to remind the user that a mode other than standard is currently selected.

The MT8852B can be made to link to an EUT and maintain the link by sending POLL packets. In response to a POLL packet, the EUT will return a NULL packet. A NULL Packet has no payload but can be used for power, initial frequency, drift, and modulation measurements without having to activate test mode.

Chapter 7. Configuring the MT8852B

This chapter provides:

- Explanations of the configuration settings accessed by pressing the **Config** hard key.

Introduction

The MT8852B is configured from menu entries accessed by pressing the **Config** hard key. The menu entries are used to configure the equipment under test (EUT), the MT8852B, and the way in which the test scripts are run. This chapter describes the procedures for configuring the MT8852B.

The table below represents the hierarchy of commands that can be accessed from the **Config** hard key. The column on the left represents the items that are first displayed. The items contained within each selection are shown in the second column and, where appropriate, in the third column.

MT8852B	Identity	BT address Name Serial no Version Core boot Core code Core FPGA RF FPGA DSP RF pcb serial no RF pcb revision Control pcb serial no Control pcb revision
	System interface	GPIB address RS232 baud rate RS232 mode RS232 parity RS232 data length RS232 stop
	Display/sound	Display contrast Key click Entry error beep User text display Enter user text Follow test
	RX/TX settings	Range FSK Modulation index Link timeout FSK Bandwidth Filter
	Audio	ACL connect status SCO channel status Packet type Air code format SCO loopback Tone generator AFH EUT rep. rate Input coding format Input data format Input sample size Linear PCM bit posn

	Rear Panel Output	BNC Output 1 BNC Output 2
	Signal generator	Pattern RF power Channel frequency Modulation index Sig Gen Pwr level
	CW Measurement	Gate width Channel frequency
	AFH Measurements	ACL Status EUT Reporting EUT Rep. Rate TX Level
Equipment Under Test	View user friendly name	EUT address EUT user friendly name
	View supported features	EUT supported features
	EUT RS 232 setup	Baud rate Parity Data length Stop bits
	Inquiry/Paging setup	End inquiry after End paging after Read name on inq Page scan rep mode
	Authentication Setup	Authentication PIN Length PIN Code
All Scripts Setup	Loop stop on test fail Loop continuously Loop count Display frequency as	
System features	Connection control	ACL connection & features Connection packet control Disconnect from EUT Make me an EUT Inquiry scan is OFF/ON
	EUT Remote Power Control	Increment EUT power Decrement EUT power Set EUT power to maximum Set EUT power to minimum
	Software Update	Bootload
	Errata 1158 is ON/OFF	
	Feature Control	Unit serial number Option number Option enable code
Service	This selection is provided for use by qualified service personnel and is password protected. There are no service procedures described in this manual.	

 Gray sections in the table above indicate that there are no further items.

Setting up the EUT

Viewing the EUT Address and User Friendly Name

Each item of *Bluetooth* equipment has a unique identifier called a BT address. This is in the form of a 12 character hexadecimal address. Equipment can also be given a meaningful name. This selection lets you view the address and user-friendly name of the equipment under test.

1. Press the **Config** hard key.
2. Select "Equipment Under Test (EUT)".
3. Press the **Sel** key.
4. Select "View user friendly name".
5. Press the **Sel** key.
6. If the MT8852B is already in a link with the EUT, this screen will immediately display the EUT address and User-friendly name.

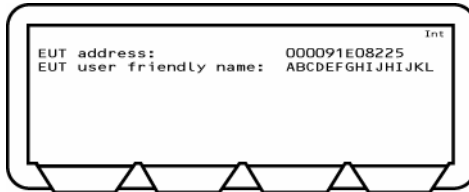

7. The user-friendly name can be up to 248 characters but will be truncated to 177 characters on the screen.
8. Press the **Back** key to exit this screen.

Viewing Supported Features

Bluetooth equipment can support a number of optional features defined in the Bluetooth specification.

1. Press the **Config** hard key.
2. Select "Equipment Under Test (EUT)".
3. Press the **Sel** key.
4. Select "View supported features".
5. Press the **Sel** key.
6. If the MT8852B is already in a link with the EUT, this screen will immediately display the first EUT supported features screen as shown below.

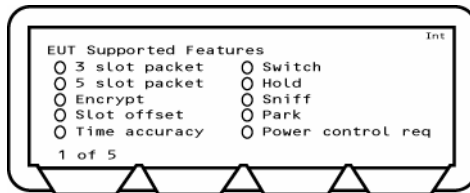

7. A filled-in ellipse indicates supported features. Unsupported features show an empty ellipse.
8. Press the extreme left soft key (**[1 of 5]** etc) to move through all four screens in this section.
9. Press the **Back** key to exit this screen.

Setting Up the EUT Control

The control setup enables you to configure the serial communications that are used to link the HCI of the equipment under test to the MT8852B tester.

1. Press the **Config** hard key.
2. Select "Equipment Under Test (EUT)".
3. Press the **Sel** key.
4. Select "EUT RS232 setup".
5. Press the **Sel** key.

The EUT RS232 setup screen is displayed.

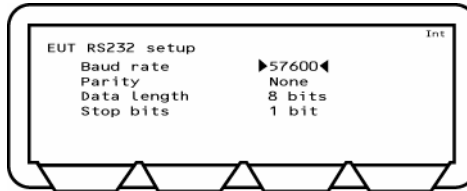

- The RS232 baud rate can be 1200, 2400, 4800, 9600, 19200, 38400, 57600, 115200, 230400, 460800, or 921600 baud but must be the same at both ends.
6. Select the item that you want to change.
 7. Repeatedly press the **Sel** key until the required value is displayed.
 8. Press the **Back** key to exit this screen.

Setting Up Inquiries

The Inquiry feature is provided to read the address directly from the EUT through the radio interface. This procedure sets up the conditions for making an Inquiry.

1. Press the **Config** hard key.
2. Select "Equipment Under Test (EUT)".
3. Press the **Sel** key.
4. Select "Inquiry/Paging setup".
5. Press the **Sel** key.

The EUT Inquiry setup screen is displayed.

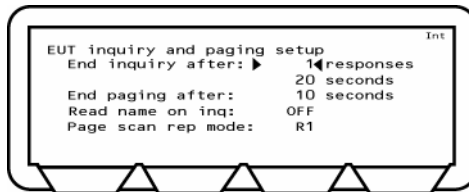

You can set the Inquiry to end after the displayed number of responses (1 to 50) or within the specified number of seconds (5 to 60). If the number of responses is set to "1" as in the example above, the MT8852B automatically connects to the first device that is located when the inquiry is performed. If the response setting is set to a value other than "1" the user must select the required device manually when the inquiry is complete. If the MT8852B is connected directly to the EUT or there is known to be only one EUT that will respond to an inquiry, set the number of responses to 1 for the fastest operation.

6. Select "End paging after".
7. Press the **Sel** key.
8. Enter the number of seconds for which the MT8852B will page the EUT before timing out. Settings at this item may be required to minimise delay for those users who know that a connection will not be established by waiting if unsuccessful within a given number of seconds. The default time is 10 seconds, and settings of between 2 and 30 seconds are possible.
9. Select "Read name on inq" and press the **Sel** key to change the status between ON and OFF.
10. Select "Page scan rep mode" and press the **Sel** key to change the status between R0, R1, and R2 to match the requirements of the EUT.
11. Press the **Back** key to exit this screen.

Setting Up Authentication

Authentication is the process of configuring a *Bluetooth* unit to connect only to one specified device. A headset, for example, can be configured to connect only to a specific mobile phone, and in this case, verification processing is used to ensure that the correct connections have been established. The MT8852B can be configured to use authentication during the establishment of a connection.

Note: The MT8852B does not use authentication by default.

The process of authentication involves creating a common key, referred to as the link key, between the master and slave devices. Security could be compromised if this link key were sent between devices, so instead, it is generated from a random number and a Personal Identification Number (PIN) which can be entered into the MT8852B. If authentication is required but the *Bluetooth* devices do not have a common link key, the authentication procedure is completed using the PIN input, and a link key is then created and stored during the authentication procedure. The link key stored in the *Bluetooth* device can then be used during any future connection. Follow the procedure below to configure the MT8852B to use authentication.

1. Press the **Config** hard key.
2. Select "Equipment Under Test (EUT)".
3. Press the **Sel** key.
4. Select "Authentication Setup".
5. Press the **Sel** key.
6. The Authentication setup screen is displayed as shown below.



7. Select "Authentication" and press the **Sel** key to toggle between "Disabled" and "Enabled".
8. Select "PIN Length" and press the **Sel** key.
9. Enter a pin length between 1 and 16 and press the "Enter" soft key.
10. Select "PIN Code" and press the **Sel** key.
11. Enter the required alphanumeric value, dependant upon PIN length and press the "Enter" soft key. The MT8852B will use this PIN key during all subsequent connections to any EUT.

Making an Inquiry:

1. Press the **Script** hard key.
2. Press the **[EUT addr]** soft key.

The EUT address screen is displayed.

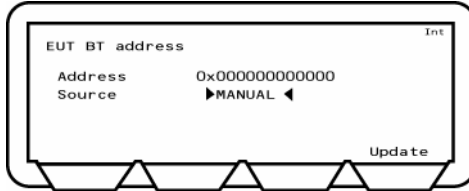

3. Select "Source".
4. Press the **SEL** key to switch repeatedly until "Inquiry" is displayed.
5. Press the **[Update]** soft key to initiate the inquiry.
6. Press the **Back** key to exit this screen.

Setting up the MT8852B

This section provides the procedures for setting up the MT8852B in order to run the tests.

Displaying the Identity of the MT8852B

1. Press the **Config** hard key.
2. Select “MT8852B”.
3. Press the **Sel** key.
4. Select “Identity”.
5. Press the **Sel** key.

The MT8852B identity screens are displayed.

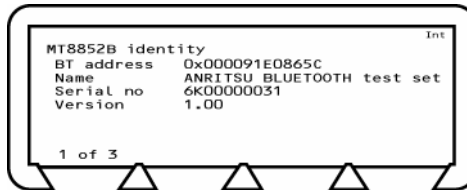

Screen 1 shows the *Bluetooth* address, user-friendly name, serial number and software version number.

6. Press the **[1 of 3]** soft key to move to the second page.

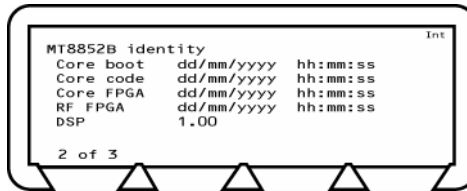

Screen 2 shows the different software modules and the date and time of creation.

7. Press the **[2 of 3]** soft key to move to the third page.

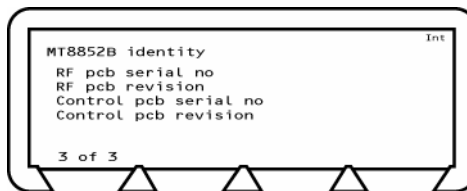

8. Press the **Back** key to exit this screen.

Configuring the System Interfaces

The MT8852B can be controlled remotely from a PC through the GPIB or the RS232 serial connecting ports on the rear of the instrument. This menu configures the settings of these two interfaces.

1. Press the **Config** hard key.
2. Select "MT8852B".
3. Press the **Sel** key.
4. Select "System interfaces".
5. Press the **Sel** key.

The System Interfaces screens are displayed.

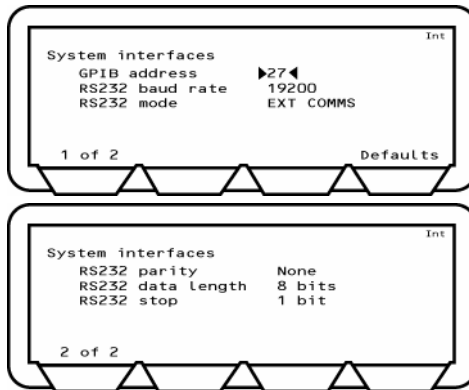

- The GPIB address is the address by which the remote computer will recognise the MT8852B.
 - The RS232 baud rate can be 1200, 2400, 4800, 9600, 19200, 38400 or 57600 baud but must be the same at both ends.
 - The RS232 mode can be EXT HCI when using an external PC for system debugging or EXT COMMS during normal operation.
 - The RS232 Parity can be 0, 1 or None.
 - The RS232 Data length can be 7 or 8 bits
 - The RS232 Stop can be 1 or 2 bits.
6. Select the item that you want to change.
 7. Repeatedly press the **Sel** key until the required value is displayed.
 8. Press the **[1 of 2]** soft key to move to the second screen or the **[2 of 2]** soft key to move back to the first screen.
 9. Press the **[Defaults]** soft key to restore the factory set default values for the system interfaces.
 10. Press the **Back** key to exit this screen.

Setting the Screen Display and Sound

You can determine how the user interface will operate.

1. Press the **Config** hard key.
2. Select "MT8852B" and press the **Sel** key.
3. Select "Display/sound".
4. Press the **Sel** key.

The MT8852B Display/sound screens are displayed.

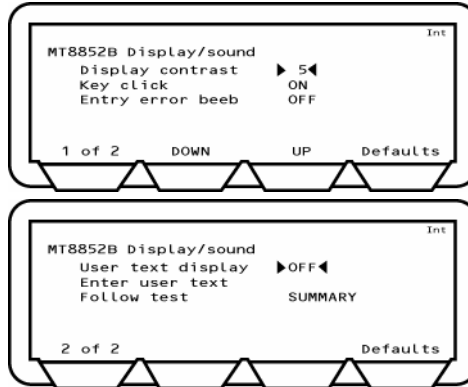

- | | |
|-------------------|--|
| Display contrast | The display contrast reduces or increases the lighting to the display in the range of 1 (light) to 10 (dark). |
| Key Click | When set to ON, will cause the instrument to click each time a key is pressed. |
| Entry error beeb | When set to ON will cause the instrument to beep when you enter the wrong information through the keypad. |
| User text display | When set to ON, will enable user text of up to 15 characters to be displayed on the top line of the screen. When set to ON, you can select Enter user text and enter the required text using the keypad. |
| Follow test | Set to have either the "SUMMARY" or "EXTENDED" results page display automatically whilst the tests in the script are running. If "Follow test" is set to "OFF", the results pages must be displayed by the user once the tests in the script are complete. |

5. Select the item that you want to change.
6. For the ON/OFF values, press the **Sel** key to toggle the value.
7. Press the **[1 of 2]** soft key to move to the second screen or the **[2 of 2]** soft key to move back to the first screen.
8. Press the **[Defaults]** soft key to restore the factory set default values for the system interfaces.
9. Press the **Back** key to exit this screen.

Setting the Range Hold

The Range Hold facility allows you to fix the MT8852B measuring receiver on a given range and disable the auto-range feature.

1. Press the **Config** hard key.
2. Select "MT8852B".
3. Press the **Sel** key.
The MT8852B Configuration screen is displayed.
4. Select "RX/TX settings".
5. Press the **Sel** key.

The MT8852B RX/TX settings screen is displayed.

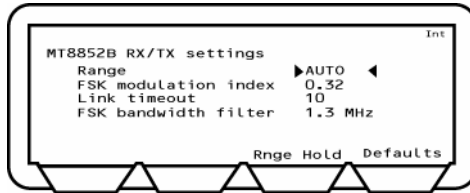

6. Highlight the Range hold value.

The values are Auto, 1 2, 3, 4, 5 and 6.

- Auto is the default setting.
- RGH1 represents a range of +22 to +7 dBm.
- RGH 2 represents a range of +9 to -3 dBm.
- RGH 3 represents a range of +5 to -7 dBm.
- RGH 4 represents a range of -4 to -16 dBm.
- RGH 5 represents a range of -12 to -26 dBm.
- RGH 6 represents a range of -24 to -35 dBm.

When any of the numbered ranges is displayed, the value will be displayed on the top line of the screen.

When the value is Auto, the **[Range hold]** soft key is displayed and will cause the current range to be held when pressed.

7. Repeatedly press the **Sel** key until the required value is displayed.

Setting the modulation index

The modulation index is the Deviation/Modulation rate. For normal *Bluetooth* operation this should be set to 0.32. To test an EUT under other conditions, the modulation index can be set to other values.

1. Press the **Config** hard key.
2. Select "MT8852B" and press the **Sel** key. The MT8852B Configuration screen is displayed.
3. Select "RX/TX settings".
4. Press the **Sel** key.

The MT8852B RX/TX settings screen is displayed.

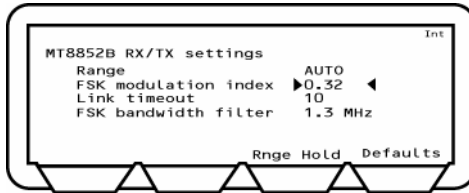

5. Highlight the Modulation index value.

The modulation index can be in the range 0.25 to 0.40. The default value is 0.32.

6. Enter the value using the keypad.

Setting Up the Link Timeout

The link timeout is the number of seconds for which the MT8852B will continue to try to communicate with an EUT even when it receives no response. If the MT8852B receives no response from the EUT after the set number of seconds, it will stop transmitting and display the message, "Connection lost, timed out" at the top of the screen. The default setting is 10 seconds and can be set between 1 and 40 seconds.

Setting Up the IF Bandwidth Filter

The user can select between two MT8852B receiver bandwidth filters. Selectable filters, as defined by their 3 dB bandwidth, are 2 MHz and 1.3 MHz, although 1.3 MHz is the default setting and the most commonly used. Both filters have a flat frequency response from $F_c \pm 550\text{kHz}$. Both filters meet the requirements of the *Bluetooth* RF test specification including errata 227. The narrower, 1.3MHz filter should be selected when wanting to reject all EUT signals outside of a single *Bluetooth* channel.

Setting Up the Signal Generator

The signal generator allows you to define and generate a continuously modulated *Bluetooth* signal. The signal generator is switched on using the **[Enable]** soft key and switched off using the **[Exit]** soft key or pressing the **[Preset]** button. The signal generator parameters can be changed when required.

1. Press the **[Config]** hard key.
2. Select "MT8852B".
3. Press the **[Sel]** key.
4. Select "Signal generator".
5. Press the **[Sel]** key.

The MT8852B Signal generator screen is displayed.

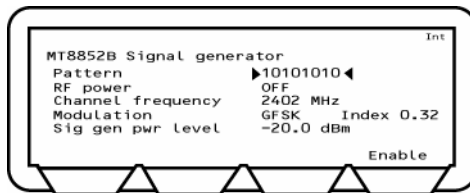

You can switch the modulating bit pattern between 10101010, 11110000, PRBS9, PRBS15, and CW, where CW is an unmodulated carrier wave.

- "RF power" can be switched ON or OFF.
 - "Channel number" can be in the range -2 to 80. This can also be entered as a frequency depending on how the test script operation has been set up.
 - "Modulation index" can be in the range 0.2 to 0.4.
 - "Sig gen pwr level" range from 0 to -90 dBm.
6. Select the item that you want to change.
 7. Repeatedly press the **[Sel]** key until the required value is displayed or enter a value using the keypad as appropriate.

Setting Up the *Bluetooth* Interferer

The MT8852B can be set up to perform the functionality of a *Bluetooth* interferer as defined in the *Bluetooth* RF test specification. This functionality allows the user to reduce overheads by removing the need to purchase expensive digital signal generators.

1. Press the **Config** hard key.
2. Select "MT8852B".
3. Press the **Sel** key.
4. Select "Signal generator".
5. Press the **Sel** key.

The MT8852B Signal generator screen is displayed.

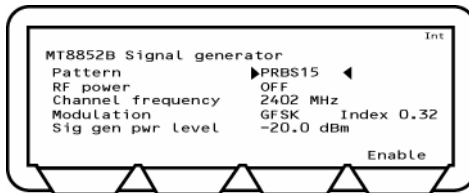

6. Move the cursor to Pattern and press the **Sel** key until the display changes to "PRBS15".

Configuring the Rear Panel Outputs

On the MT8852B, the user can configure the TX and RX signals that are routed to the rear panel BNC connectors.

1. Press the **Config** hard key.
2. Select "MT8852B".
3. Move the cursor to "Rear Panel Output" and press the **Sel** key.
4. Press the **Sel** key to page between the output types. There are five possible settings available for each output, although selection of specific output types restricts the types available at the other port.
 - Output 1 can never be RXON and Output 2 can never be TXON.
 - If Output 1 is TXON, output 2 can be any value.
 - If Output 2 is RXON, output 1 can be any value.
 - Otherwise Output 1 and Output 2 must be set to the same value.

This is summarised in the table below.

		Output 1				
		TX ON	TX CH0 PULSE	RX DATA	TX DATA	CORR FIRED
Output 2	RXON	✓	✓	✓	✓	✓
	TX CH0 PULSE	✓	✓			
	RX DATA	✓		✓		
	TX DATA	✓			✓	
	CORR FIRED	✓				✓

The meaning of each of the signals is detailed below.

TX ON: MT8852B TX on

RXON: MT8852B RX on

TX CH0 PULSE: MT8852B transmitted packet on channel 0.

RX DATA: MT8852B received data, provides a TTL output of all the received packet bits, including preamble, header and payload.

TX DATA: MT8852B transmitted data, provides a TTL output of all the transmitted packet bits, including preamble, header and payload.

CORR FIRED: MT8852B correlator fired, provides a TTL pulse when the MT8852B correlator fires, giving an indication of the flow of good received packets.

Performing Continuous Wave Measurement

The MT8852B can measure a fixed frequency signal to calibrate power, frequency, and modulation. The CW measurement mode is intended only for the measurement of continuous non-packetized signals and does not support triggering.

1. Press the **Config** hard key.
2. Select “MT8852B”.
3. Move the cursor to “CW Measurement” and press the **Sel** key.
4. CW Measurement is commenced using the **[Enable]** soft key and switched off using the **[Exit]** soft key or pressing the **Preset** button.

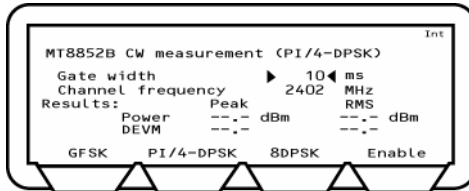

“Gate width” defines the measurement window. Settings can be made between 1 and the default setting of 10 ms.

“Channel frequency” may be replaced with “Channel number” depending on the setting that has been made at “Display frequency as” on the All scripts setup page (detailed in the following section of this manual.) The default channel number is 2, with settings possible in the range of –2 to 98.

Note: No results will be displayed in the modulation field if the received power level drops below -40 dBm.

Setting Up Test Script Operation

You can determine how test scripts are run.

1. Press the **Config** hard key.
2. Select "All Scripts Setup".
3. Press the **Sel** key.

The Scripts setup screen is displayed.

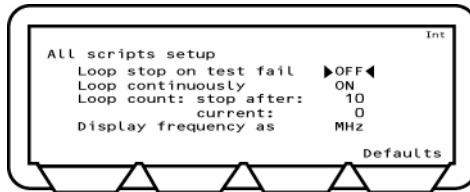

- "Loop stop on test fail", when ON, will run the test repeatedly until a failure is recorded or the test is stopped.
 - "Loop continuously", when ON, will run the test until it is stopped.
 - "Loop count" will run the test for the number of loops defined. When Loop stop on failure or Loop continuously is set to ON, this will display N/A they take precedent.
 - "Display frequency as" will determine whether a channel is displayed in number format (0 to 78) or by actual frequency in MHz.
 - Current will display the number of completed loops when the instrument is in loop mode.
4. Select the item that you want to change.
 5. For Loop stop on failure, Loop continuously and Display frequency, press the **Sel** key to switch the values. For Loop count, enter the value using the keypad.

System features

Setting the Link

1. Press the **Config** hard key.
2. Select “System features”.
3. Press the **Sel** key.
4. Select “Connection control”.
5. Press the **Sel** key.

The connection control screen is displayed.

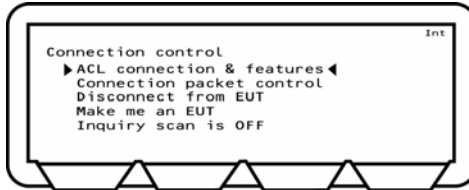

From this screen you can determine how the asynchronous link (ACL) will operate. The choices are:

- “ACL connection & features”
 - “Connection packet control”
 - “Disconnect from EUT”
 - “Make me an EUT” - You can make the MT8852B behave as equipment under test. This means that it is page scanning with test mode enabled.
 - “Inquiry scan is ON/OFF” - The Inquiry feature allows the instrument to respond to an inquiry from another device. It is especially useful for synchronizing with some *Bluetooth* protocol analyzers. The protocol analyzer can then monitor the messages between the MT8852B and the EUT.
6. Select the operation that you require and press the **Sel** key.

Note: Connection Timer:

If option 15 (AFH) is enabled, the time taken to establish a connection displays on the top line of the screen shown above. An example of the display is shown below.

```
Connection made (1: 1054 ms)
```

The digit prior to the colon (“1” in the case of the example above) represents the number of attempts required to establish the connection. The figure following the colon represents the time in milliseconds taken to establish the connection.

Setting Remote Power Control

1. Press the **Config** hard key.
2. Select “System features”.
3. Press the **Sel** key.
4. Select “EUT Remote Power Control”.
5. Press the **Sel** key.
6. The EUT Remote Power control screen is displayed.

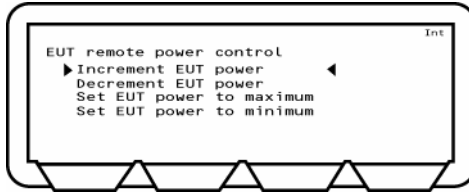

This screen allows the operator to control the EUT power incrimination.

- Select Increment / Decrement EUT Power to increment or decrement the EUT power by one increment.
 - Select Set EUT Power to Maximum / Minimum to have the MT8850/52A continuously send increment (or decrement) power commands until the EUT reports that the maximum (or minimum) power has been reached.
7. Select the operation that you require and press the **Sel** key.

Updating the Software

CAUTION

Do not use this procedure unless you have updated software and intend to update it at this time. Once you have chosen Bootload and pressed the **Sel** key, the instrument will expect a firmware download. To recover from this status, if the firmware upgrade is not performed, it is necessary to disconnect the instrument from the mains power supply by removing the power cord from the rear panel of the instrument.

Software updates can be downloaded from a PC connected to the MT8852B through the GPIB or RS232 connector. This can only occur when Bootload is selected.

1. Press the **Config** hard key.
2. Select "System features".
3. Press the **Sel** key.
4. Select "Software update".
5. Press the **Sel** key.

The MT8852B Software update screen is displayed.



6. Select "Bootload".
7. Download the software upgrade from the connected PC.

The download procedure requires that you copy some files from the upgrade disk and run a batch program to implement the changes. This is described in the Readme document supplied on the upgrade disk.

CAUTION

Do not stop the upgrade once started, as you will not be able to restore the instrument to operation. If this should occur because of a PC breakdown, contact your Anritsu Service Center for advice.

Errata 1158

Errata 1158 is an approved amendment to the *Bluetooth* core specification version 1.1. It is used to apply a form of data whitening for *Bluetooth* links in test mode. If the protocol set of the EUT does not implement Errata 1158 this should be set to OFF.

1. Press the **Config** hard key.
2. Select “System features”.
3. Press the **Sel** key.
4. Select “Errata 1158”.
5. Press the **Sel** key to toggle between on and off.

Service

This selection is provided for use by qualified service personnel and is password protected. There are no service procedures described in this manual.

Chapter 8. Using the Script Menu

This chapter provides:

- Details of the test script settings.
- An overview of each of the standard and EDR measurements available.

Introduction

The MT8852B gives the user access to ten test scripts. Scripts 1 and 2 are non-editable, but scripts 3 to 10 can be configured freely and password protected if required.

Press the **Script** button to display the initial script entry screen. For the sake of convenience, the tests have been split into standard and EDR measurements, but when a script is run, all of the available and selected tests (both standard and EDR) are performed in sequence.

As illustrated in the table below, each script can contain up to a maximum of 14 tests, and each test can be configured to match the exact testing requirements.

Standard measurement	EDR measurements
Output power	Rel Tx power
Power control	Carrier & modulation
Initial carrier	Diff phase
Carrier drift	EDR sensitivity
Single sensitivity	EDR BER floor
Multi sensitivity	Max input level
Modulation index	
Max input power	

Accessing the Script Menu

1. Press the **Script** hard key to access the script entry screen.

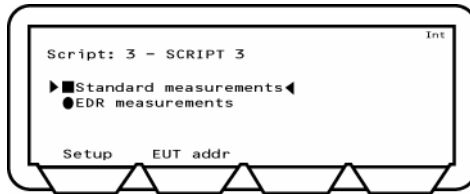

The script entry screen allows the user to:-

- Turn on or off all standard or EDR measurements for any of the editable scripts.
- Select the script number.
- Access a list of all tests (standard and EDR) within the selected script.
- View and specify the EUT address.

The script entry screen shown above and the subsequent Setup screens use a number of round and square icons to indicate the status of the test or test group. These icons are defined below.

- Indicates that the test or test group is available for use and is currently selected.
- Indicates that the test or test group is available for use but is not currently selected.
- The round circle indicates that the unit is currently unable to determine whether the test or test group is available for the EUT in question. The solid black circle indicates that the user wishes to perform this test(s) if possible.
- The round circle indicates that the unit is currently unable to determine whether the test or test group is available for the EUT in question. The solid white circle indicates that a) the user does not wish to perform this test(s) even if available, or b) the test is unavailable and cannot be performed under the current test conditions.

Move the cursor to either the Standard or EDR measurement items and press the [Setup] soft key to display the associated script menu.

The script menu allows the user to :-

- Lock, unlock and edit the scrip name. You can also change your password from within this selection.
- Select and run the selected script.
- Set up individual tests and set the limits of that test.
- Check the address of the equipment under test.
- Run a single test.
- Display the results of a test.

Locking and Unlocking a Script

You can access any of the 10 scripts in order to edit the script name, lock/unlock a script (scripts 3 to 9 only) and set or change the access password.

1. Press the **Script** hard key to display the script entry screen.

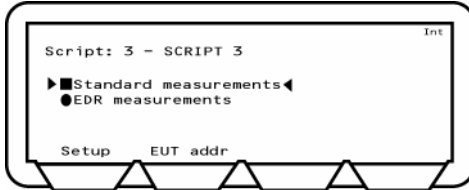

2. Position the cursor on either the standard or EDR measurement items and press the [Setup] soft key to display the associated script menu.

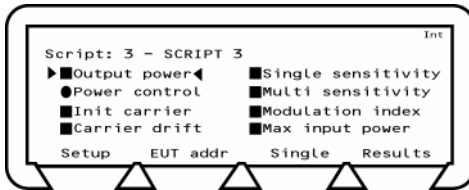

3. Move the cursor to the Script number.

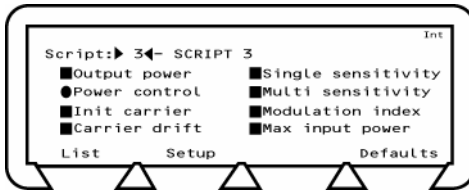

The soft keys change to **[List]** and **[Setup]**. **[List]** will display a list of scripts and **[Setup]** will take you to the Path Loss table for script named.

4. Press the **[List]** soft key.

The Script list screens are displayed.



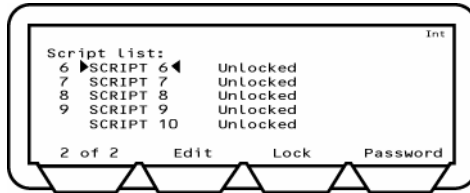

5. **To change the name of a script:** Select the script, press the **[Edit]** soft key and enter a name from the keypad. Press the **[Enter]** soft key.

Note: The Edit key is only available if the script is unlocked.

6. **To lock/unlock the script:** Select the script, press the **[Lock]** or **[Unlock]** soft key.

Note: You may need to enter a password. If you have not changed the password, the factory default is 1234.

7. Enter the password using the keypad.
8. Press the **[Enter]** soft key.

Changing the Password

1. Select the script and press the **[Edit Passwd]** soft key.

The Script password screen displays.



2. Enter the current password using the keypad. If a mistake is made, press the **CLR** key to delete the character at the cursor and move the cursor one place to the left.

Note: The factory default password is 1234.

3. Press the **[Enter]** soft key.
4. Enter the new four-digit password and press the **[Enter]** soft key
5. Confirm the new password and press the **[Enter]** soft key again to save the password.

Running the Tests

The script menu provides access to configuration settings, individual tests, and test results.

1. Press the **Script** hard key to display the script entry screen.

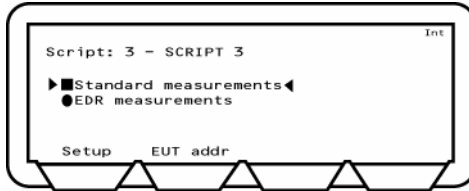

2. Select the script to be run by positioning the cursor to the script number and following procedure (a) or (b) below.
 - (a) Press the **Sel** key, enter the number of the script to be run from the keypad and press the **[Enter]** soft key.
 - (b) Press the **[List]** soft key, move the cursor to the test script to be run and press the **Sel** key.
3. Move the cursor back into the measurement area of the screen. Press the **[EUT addr]** soft key to enter the BT address of the EUT.
4. Press the **Run** hard key to run the test script once, or press the **Loop/Stop** hard key to run the test script according to the configuration settings of the MT8852B. Press the **[Abort]** soft key to terminate the script immediately. Press the **Loop/Stop** hard key again to stop a continuous script running.
5. To check the configuration of the script prior to execution, position the cursor on either the standard or EDR measurement items and press the **[Setup]** soft key to display the associated script menu. The round and square icons indicate the status of each test within the script (refer to the earlier explanation).

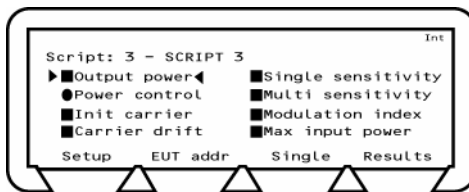

6. When the tests are running, the results display in line with the "Follow test" setting made by the user. The "Follow Test" setting gives the user the choice of displaying the Extended or Summary results screens whilst the tests are being performed. If "Follow test" is set to "OFF", the results pages must be displayed by the user once the tests in the script are complete. Regardless of the "Follow test" setting, the display returns to the test script page when all the tests are complete.
7. Press the **[Results]** soft key to view the results obtained from the tests.
8. The results given on the initial screen are a summary of the tests conducted. For more detailed results press the "Extended" soft key. An extended screen is displayed for each of the test combinations. For example, if a test is performed at

high, medium, and low frequencies, with hopping both on and off, there could be up to six extended screens, and the user can page through these in the normal manner by pressing the “1 of 6” soft key.

Setting Up General Script Parameters

1. Press the **Script** hard key to display the script entry screen.

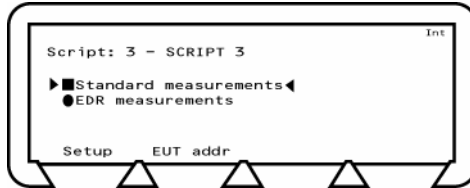

2. Move the cursor to the script number and press the **[Setup]** soft key to display the setup screens.

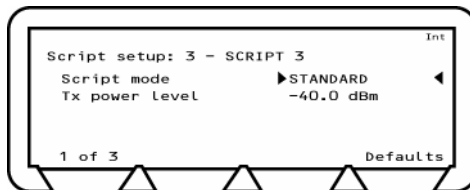

3. Specify the script mode.

Press the **[Sel]** key to toggle the script mode setting between “Standard”, “Null Packet”, and “Single Payload”.

4. Enter the “TX power level” value using the keypad.

You can set the transmission power level to between 0 and -90 dBm. TX power level sets RF power of the MT8852B transmitter. This power level is used for link setup and all measurement with the exception of EUT receiver sensitivity and maximum input power.

5. Press the **[1 of 3]** soft key to move to the second screen.

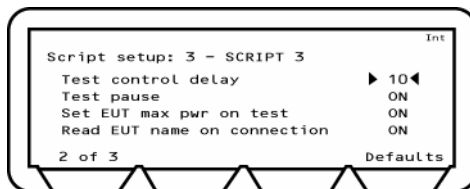

Test control delay

The Test Control delay value can be set to any value between 0 and 100. When the MT8852B sends a Test Control command (Loopback, TX or Test Pause) the EUT may require a period of time to respond before it has actioned the Test Control. This time will vary between differing *Bluetooth* developers implementations. Test control delay causes the MT8852B to pause from measuring returned packets until the EUT has had time to respond. The number entered is the number of transmitted packets from the MT8852B that are ignored before measurements are started.

Test Pause

1. The Test Pause setting is defined in the *Bluetooth* specification to improve the efficiency of device testing. If an EUT does not support test pause, use of test pause can be disabled by moving the cursor to “Test Pause” and pressing the **Sel** key to change the setting to Off.

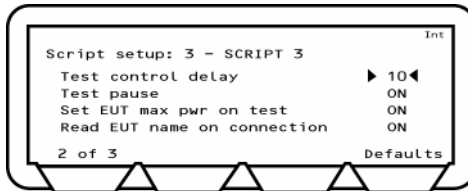

EUT Settings on Connection

The two settings on the screen above that appear below test pause are set by default to “ON” and should be left at this setting unless required as detailed below.

When the MT8852B connects with an EUT it is required by the specification that the power be set to maximum. However, as it has been found that this requirement may pose a problem for certain EUTs in development, it is now possible to set “**Set EUT max pwr on test**” to “OFF”.

In a similar manner to the setting above, it is also possible to set “**Read EUT name on connection**” to “OFF”. Under normal circumstances, the user-friendly name is read when a connection is established. However, for certain EUTs still in development, this may result in a dropped link, and for this reason it can be set to “OFF”.

1. Press the **[2 of 3]** soft key to move to the third screen.

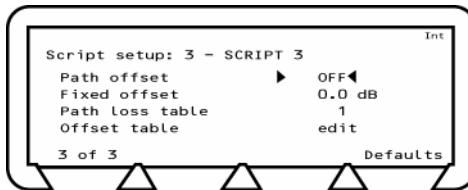

Setting the Path Offset

You can set the path offset to OFF, FIXED, or TABLE. The meanings of each of the path offset settings are detailed below.

Path offset = OFF

When the path offset is OFF you are unable to carry out any activity with the fixed offset and path loss tables and these values are set to N/A.

Path offset = FIXED

When the path offset is fixed, you can enter the fixed offset value. Enter the offset value from the keypad and press the **Sel** key. It should be noted that values must be entered in the negative by first pressing the **+/-** key.

Path offset = TABLE

A setting of table allows the user to specify one of five loss tables for the selected script. To do this, move the cursor to "Path loss table", press the **Sel** key and enter the number (1 to 5) of the loss table that will be used. Press the "Enter" soft key when the selection has been made.

Creating or Editing a Path Offset Table

Path offset tables can be created or edited in the manner described below.

1. Specify the table number (1 to 5) at the “Path loss table” item as described in the explanation above.
2. Position the cursor at the “edit” item directly beneath the table number and press the **Sel** key.
3. An offset value can be specified for any or all of the 79 frequencies used. Press the “Frequency” soft key, press the **+/-** key on the keypad, and then enter the associated offset.
4. When the “Enter” soft key is pressed the cursor is automatically positioned to allow input of the offset value.
5. Repeat this procedure until all of the required offsets have been specified.

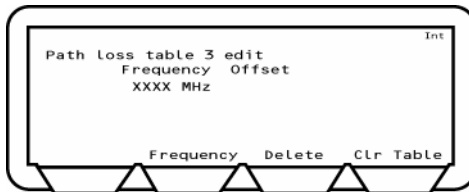

All offsets specified are applied to the EUT transmitter power measurement, the EUT receiver sensitivity measurement, and the receiver maximum input power measurement. If, for example, an offset of 15 dB is specified, 15 dB is added to the measured EUT power, and the MT8850A transmitter has 15 dB extra power transmitted to allow for the offset.

Setting Up Tests

The tests that can be performed in each of the three script modes, and the settings that are required to enable the tests are illustrated in the table below. Tests that cannot be performed or are not available in this release of the software are highlighted in grey. Single payload tests will only be available when the indicated settings are made.

		Standard	Single payload	Null packets
Standard measurements	Output power	Supported	Test control: TX or Loopback Payload: Any Packet type: Any Hopping: On or Off	Supported
	Power control	Supported	Not available	Not available
	Init carrier	Supported	Test control: TX or Loopback Payload: Any Packet type: Any Hopping: On or Off	Supported
	Carrier drift	Supported	Test control: TX or Loopback Payload: 10101010 Packet type: Any Hopping: On or Off	Supported
	Single sensitivity	Supported	Test control: Loopback Payload: PRBS9 Packet type: DH1 Hopping: On or Off	Not available
	Multi sensitivity	Supported	Test control: TX or Loopback Payload: PRBS9 Packet type: DH3 or DH5 Hopping: Off	Not available
	Modulation index	Supported	Test control: TX or Loopback Payload: 10101010 or 11110000 Packet type: Any Hopping: Off	Supported
	Max input power	Supported	Not available	Not available
EDR measurements	Rel Tx power	Supported	Not available	Not available
	Carrier & mod	Supported	Not available	Not available
	Diff phase	Supported	Not available	Not available
	EDR sensitivity	Supported	Not available	Not available
	EDR BER floor	Supported	Not available	Not available
	EDR max input level	Supported	Not available	Not available

Testing in Standard Script Mode

Individual tests can be tailored to suit requirements. The setup procedures and limits are described on the following pages:

Output Power Test (Standard Mode)

The output power test performs power measurements on the EUT transmitted packets in one of four ways.

With “Hopping test mode” set to “Defined” the MT8852B measures power only when the link hops to one of the frequencies defined on the LOW, MEDIUM and HIGH set up screen. Although the measurements are only made at the defined frequencies, it is still a hopping link. The number of packets measured at each frequency is set by the user in the “Number of packets” field. This is the test method described in the *Bluetooth* RF Test Specification.

With “Hopping test mode” set to “All” the MT8852B measures the power at every one of the 79 frequencies in the *Bluetooth* channel structure. The number of packets measured at each frequency is set by the user in the “Number of packets” field.

With “Hopping test mode” set to “Any” the MT8852B measures the power at the next frequency that the link hops to after the previous power measurement has been completed. The total number of packets measured is set by the user in the “Number of packets” field. This is typically the shortest of the three options as there is no requirement to measure a large number of packets at specified frequencies.

The MT8852B can perform the test using either loopback test controls or TX test controls. The default form for this test is to use loopback. The following test description is described using the default test control.

The MT8852B transmits a pseudo random data payload (PRBS 9) of the longest supported type (DH5, DH3 or DH1) or the selected packet type, to the EUT. The EUT loops back the data at its maximum output power and the MT8852B measures the received power. This default setting for this test to meet the requirements of the Bluetooth specification 2.0 is hopping on, hopping test mode Defined. In this case the test is performed while hopping, and the test is repeated until the requested number of packets has been measured on each of the selected frequencies. The LOW, MEDIUM and HIGH frequencies relate to the default frequencies specified in the *Bluetooth* RF test specification. The MT8852B allows all these frequencies to be changed from their default values.

It is also possible to run this test with hopping off. In this case, the frequencies tested are those listed on the second setup page.

1. Select “Output power” from the standard measurements script menu.
2. Press the **Sel** key to select or deselect this test from the script routine.

If a test is selected, the box will be filled in. If not selected the box will be hollow.

- Press the **[Setup]** soft key.

The Output power test conditions screens are displayed.

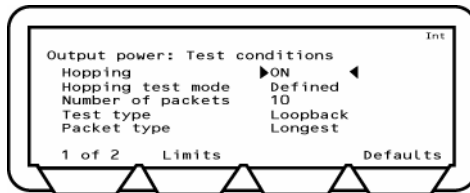

- Select "Hopping".
- Press the **[Sel]** key to switch between On, Off & On, and Off. It should be noted that if hopping is set to "Off", the "Hopping test mode" setting below is redundant.
- Select "Hopping test mode".
- Press the **[Sel]** key to switch between Defined, All and Any.
- Select "Number of packets".
- Enter the value using the keypad.
- Select Test type.
- Press the **[Sel]** key to switch between Loopback and TX.
- Select "Packet type".
- Press the **[Sel]** key repeatedly until the required packet type, Longest, DH1, DH3 or DH5 is displayed. Longest sets the packet type to the longest length that the EUT supports during the link setup process.
- Press the **[1 of 2]** soft key to move to the second screen.

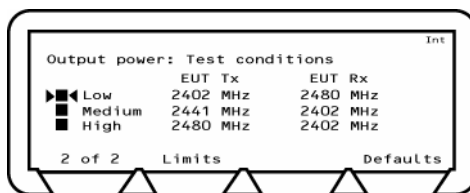

You can select or deselect the test to run and make changes to the frequency.

When the Hopping test mode is set to All or Any, the Low, Medium and High frequencies are not applicable and they are displayed as hollow ellipses.

- To select or deselect a test, select the test and press the **[Sel]** key.
- To change a frequency, select the frequency, press the **[Sel]** key, enter the value using the keypad and press the **[Enter]** soft key.
- Press the **[Defaults]** soft key to restore the default values.

18. Press the **[Limits]** soft key to display the Output power test limits screen.

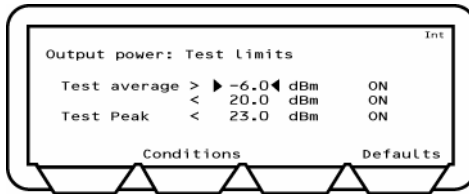

19. Press the **[Defaults]** soft key to restore the default values.
20. Select the limit you want to change.
21. Press the **[Sel]** key and enter the new limit using the keypad.
22. Press the **[Enter]** soft key.
23. Press the **[Conditions]** soft key to return to the test conditions screen.
24. Press the **[Back]** key to return to the Script menu.

Power Control Test (Standard Mode)

The power control test performs power measurement cycles on the EUT output, if the EUT supports power control, at each of the defined frequencies (LOW, MEDIUM and HIGH). This measurement is always performed with hopping off. The MT8852B can perform the test using either loopback test control or TX test control. The default form for this test is to use loopback. The following test is described using the default test control.

The MT8852B transmits a DH1 (or the operator selected packet type) packet with a pseudo random data payload (PRBS 9). This test is performed with hopping off. The LOW, MEDIUM and HIGH frequency sets relate to the default frequencies specified in the *Bluetooth* RF test specification. The MT8852B allows all the frequencies to be changed.

A power measurement cycle sets the EUT output power to its maximum and then steps the power down to the minimum power and then up to the maximum again one step at a time. For each power step a number of data packets are sent to the EUT and looped back to the MT8852B.

Note: When the test is performed in TX test mode only the TX frequency settings are used since both RX and TX frequencies must be the same.

1. Select "Power control" from the standard measurements script menu.
2. Press the **Sel** key to select or deselect this test from the script routine.
If a test is selected, the box will be filled in. If not selected the box will be hollow.
3. Press the **[Setup]** soft key.

The Power control test conditions screens are displayed.

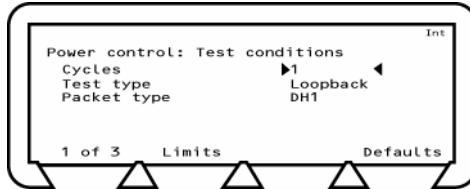

You can change the number of cycles. In one cycle the EUT goes from maximum to minimum power then returns to maximum power one power step at a time. You can also change the test type and packet type.

4. Select "Cycles".
5. Enter the value using the keypad.
6. Select "Test type".
7. Press the **Sel** key to switch between Loopback and TX.
8. Select "Packet type".
9. Press the **Sel** key to switch between DH1, DH3 and DH5.
10. Press the **[1 of 3]** soft key to move to the second screen.

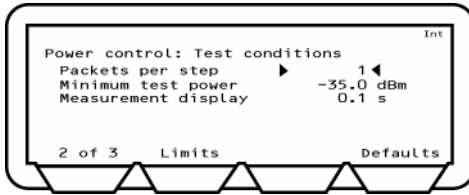

11. Select "Packets per step". Use the keypad to enter a value for the number of packers that are averaged at each power step.
12. Select "Minimum Test power". Use the keypad to enter a value for the minimum EUT power. When a power below this value is received by the MT8852B it will start sending increment power commands, even if it has not received a minimum power command from the EUT.
13. Select "Measurement delay". Use the keypad to specify the time delay between the step command and the time that measurement is commenced.
14. Press the **[2 of 3]** soft key to move to the third screen.
15. The third screen will vary according to whether the Test type is in Loopback or TX mode. The following screen is in Loopback mode.

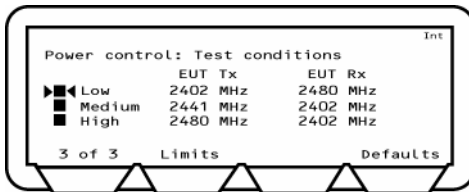

The following screen is in TX mode.

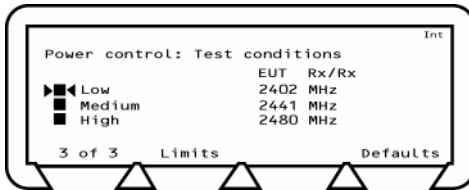

You can select or deselect the test to run and make changes to the frequency values shown.

16. To select or deselect a test, select the test and press the **(Sel)** key.
17. To change a frequency, select the frequency, press the **(Sel)** key, enter the value using the keypad and press the **[Enter]** soft key.
18. Press the **[Defaults]** soft key to restore the default values.

19. Press the **[Limits]** soft key to display the Power control test limits screen.

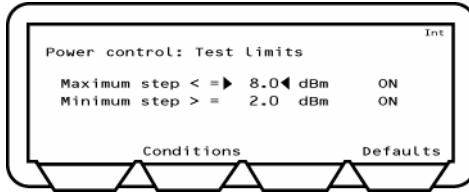

20. Press the **[Defaults]** soft key to restore the default values.
21. Select the limit you want to change.
22. Press the **[Sel]** key and enter the new limit using the keypad.
23. Press the **[Enter]** soft key.
24. Press the **[Conditions]** soft key to return to the test conditions screen.
25. Press the **[Back]** key to return to the Script menu.

Initial Carrier Test (Standard Mode)

The initial carrier test performs a frequency accuracy test on a DH1 pseudo random data packet. (PRBS 9) This test can be performed using either the loopback test control or the TX test control. The default is to use the loopback test control. This test can be made with either hopping on or off.

With hopping off, the MT8852B measures the initial carrier frequency error at the three frequencies defined on the LOW, MEDIUM and HIGH set up screen. The number of packets measured at each frequency is set by the user in the “Number of packets” field. This is the test method described in the *Bluetooth* RF Test Specification for an initial carrier frequency test with hopping off.

With hopping on, the MT8852B can make the measurement in one of three ways.

If “Hopping test mode” is set to “All”, the MT8852B will measure the initial carrier frequency at every one of the 79 frequencies in the *Bluetooth* channel structure. The number of packets measured at each frequency is set by the user in the “Number of packets” field. This is the test method described in the *Bluetooth* RF Test Specification for an initial carrier frequency test with hopping on.

If “Hopping test mode” is set to “Any” the MT8852B measures the power at the next frequency that the link hops to after the previous initial carrier frequency measurement has been completed. The total number of packets measured is set by the user in the “Number of packets” field. This is typically the shortest option as there is no requirement to measure a large number of packets at every frequency.

If hopping test mode is set to “Defined” the MT8852b will measure the initial carrier frequency each time the EUT hops to the transmit frequency set up on page 2 until the number of packets set under “Number of packets” at each of these three frequencies has been measured.

When the measurement is made using TX mode the MT8852B sets up the EUT so that when the EUT is polled it transmits a DH1 packet with a pseudo random payload for each of the frequencies selected (LOW, MEDIUM and HIGH). This test can be performed with hopping off and on. The LOW, MEDIUM and HIGH frequencies relate to the default frequencies specified in the *Bluetooth* RF test specification. The MT8852B allows all the frequencies to be changed. When the test is performed in TX test mode EUT transmitter and receiver frequencies must be the same.

1. Select “Init carrier” from the standard measurements script menu.
2. Press the **Sel** key to select or deselect this test from the script routine.

If a test is selected, the box will be filled in. If not selected the box will be hollow.

3. Press the **[Setup]** soft key.

The Initial carrier test conditions screens are displayed.

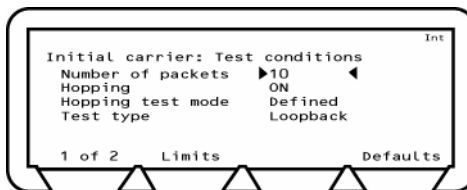

The first screen lets you enter the number of packets to send, switch hopping on or off and change test type. If hopping is on you can change the mode.

4. Select "Number of packets".
5. Enter the number of packets using the keypad.
6. Select "Hopping".
7. Press the **Sel** key to switch between ON and OFF. If you select ON, select Hopping test mode and press the **Sel** key to switch between All and Any.
8. Select Test type.
9. Press the **Sel** key to switch between Loopback and TX.
10. Press the **[1 of 2]** soft key to move to the second screen.

The second screen will vary according to whether the Test type is in Loopback or TX mode. The following screen is in Loopback mode.

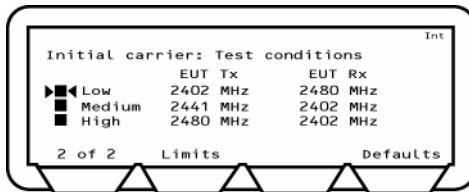

The following screen is in TX mode.

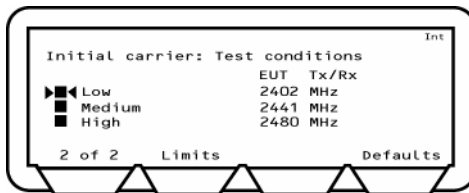

You can select or deselect the test to run and make changes to the frequency values shown.

11. To select or deselect a test, select the test and press the **Sel** key.
12. To change a frequency, select the frequency, press the **Sel** key, enter the value using the keypad and press the **[Enter]** soft key.
13. Press the **[Defaults]** soft key to restore the default values.
14. Press the **[Limits]** soft key to display the Initial carrier test limits screen.

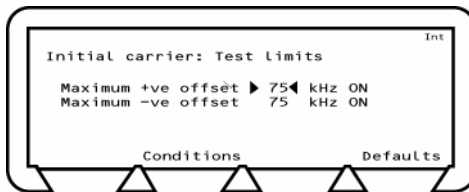

15. Press the **[Defaults]** soft key to restore the default values.
16. Select the limit you want to change.
17. Press the **[Sel]** key and enter the new limit using the keypad.
18. Press the **[Enter]** soft key.
19. Press the **[Conditions]** soft key to return to the test conditions screen.
20. Press the **[Back]** key to return to the Script menu.

Carrier Drift Test (Standard Mode)

The carrier drift test performs a frequency drift measurement over the length of the packet received. The test can be carried out for each of the supported packet types with either hopping on or hopping off. This test can be performed using either the loopback test control or the TX test control. The default is to use the loopback test control.

In loopback mode with hopping off, the MT8852B sends DH1, DH3 and DH5 packets with a 10101010.... payload at each of the frequencies selected (LOW, MEDIUM and HIGH). The EUT returns the DH1, DH3 or DH5 packet for measurement. The LOW, MEDIUM and HIGH frequencies relate to the default frequencies specified in the *Bluetooth* RF test specification. The number of packets of each length that are measured is set in the "Number of packets" field. The MT8852B allows all the frequencies to be changed. This is the test method described in the *Bluetooth* RF Test Specification for a carrier frequency drift test with hopping off.

In loopback mode with hopping on, and "Hopping test mode" set to "All" the MT8852B sends DH1, DH3 and DH5 packets with a 10101010 payload. The EUT returns the DH1, DH3 or DH5 packet for measurement. The MT8852B will measure the carrier frequency drift for each packet length at every one of the 79 frequencies in the *Bluetooth* channel structure. The number of packets of each length that are measured is set in the "Number of packets" field. This is the test method described in the *Bluetooth* RF Test Specification for a carrier frequency drift test with hopping on.

In loopback mode with hopping on, and "Hopping test mode" set to "Any" the MT8852B sends DH1, DH3 and DH5 packets with a 10101010 payload. The EUT returns the DH1, DH3 or DH5 packet for measurement. The MT8852B will measure the carrier frequency drift at the next frequency that the link hops to after the previous carrier frequency drift measurement has been completed. The number of packets of each length that are measured is set in the "Number of packets" field.

In loopback mode with hopping on, and "Hopping test mode" set to "Defined" the MT8852B sends DH1, DH3 and DH5 packets with a 10101010 payload. The EUT returns the DH1, DH3 or DH5 packet for measurement. The MT8852B will measure the carrier frequency drift when the EUT transmits on one of the frequencies set on page 2. The number of packets of each length that are measured is set in the "Number of packets" field.

In TX mode with hopping on or off the measurement process is the same as for loopback except that the MT8852B does not send full DHX packets but just POLL packets. The EUT has been configured by the MT8852B to respond to a POLL with the appropriate DHX packet. The EUT must support TX mode part of the Test Mode specification for this to work. The test time is much shorter when run using TX mode compared with loopback, as the MT8852B does not have to send full packet lengths. When the test is performed in TX test mode, EUT transmitter and receiver frequencies must be the same. TX mode complies with the *Bluetooth* RF Test Specification for a carrier frequency drift test.

1. Select "Carrier drift" from the standard measurements script menu.
2. Press the **Sel** key to select or deselect this test from the script routine.
If a test is selected, the box will be filled in. If not selected the box will be hollow.
3. Press the **[Setup]** soft key.

The Carrier drift test conditions screens are displayed.

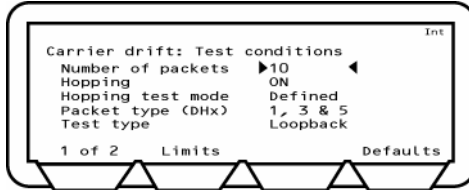

This screen lets you enter the number of packets to send, switch hopping on or off. If hopping is on you can change the mode. You are also able to set the length of the packets and change the test type.

4. Select "Number of packets".
5. Enter the number of packets using the keypad.
6. Select "Hopping".
7. Press the **Sel** key to switch between ON, OFF or ON & OFF. If you select ON, select Hopping test mode and press the **Sel** key to switch between All and Any.
8. Select "Packet type (DHx)".
9. Press the **Sel** key to switch between:
 - 1
 - 3
 - 1&3
 - 5
 - 1&5
 - 3&5
 - 1, 3 & 5
10. Select "Test type".
11. Press the **Sel** key to switch between Loopback and TX.
12. Press the **[1 of 2]** soft key to move to the second screen.

The second screen will vary according to whether the Test type is in Loopback or TX mode. The following screen is in Loopback mode.

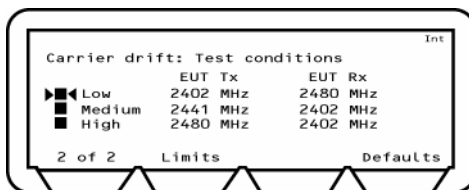

The following screen is in TX mode.

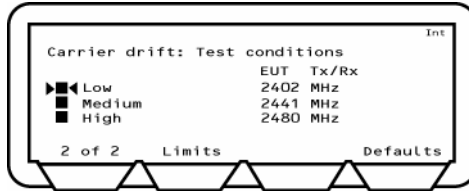

You can select or deselect the test to run and make changes to the frequency values shown.

13. To select or deselect a test, select the test and press the **Sel** key.
14. To change a frequency, select the frequency, press the **Sel** key, enter the value using the keypad and press the **[Enter]** soft key.
15. Press the **[Defaults]** soft key to restore the default values.
16. Press the **[Limits]** soft key to display the Carrier drift test limits screen.

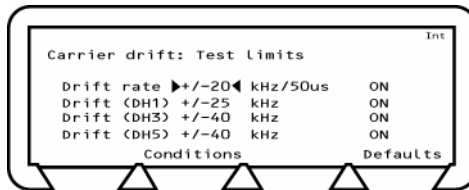

17. Press the **[Defaults]** soft key to restore the default values.
18. Select the limit you want to change.
19. Press the **Sel** key and enter the new limit using the keypad.
20. Press the **[Enter]** soft key.
21. Press the **[Conditions]** soft key to return to the test conditions screen.
22. Press the **Back** key to return to the Script menu.

Single Slot Sensitivity Test (Standard Mode)

For a single slot sensitivity measurement the MT8852B transmits DH1 packets with a pseudo random payload (PRBS 9) to the EUT at a minimum power level. If the dirty transmitter parameters are applied, then every 20 ms the MT8852B changes the transmitter parameters as specified in the dirty transmitter table for this test. The EUT loops back the received data and a bit error rate (BER) calculation and frame error rate (FER) calculation is performed by the MT8852B test set. The test is repeated for each of the frequencies selected (LOW, MEDIUM and HIGH). This test is performed with hopping off. The LOW, MEDIUM and HIGH frequencies relate to the default frequencies specified in the *Bluetooth* RF test specification. The MT8852B allows all the frequencies to be changed. This is the test method described in the *Bluetooth* RF Test Specification for a single slot sensitivity test with hopping off.

The MT8852B can also carry out this test with hopping on.

1. Select "Single sensitivity" from the standard measurements script menu.
2. Press the **[Sel]** key to select or deselect this test from the script routine.

If a test is selected, the box will be filled in. If not selected the box will be hollow.

3. Press the **[Setup]** soft key.

The Single sensitivity test conditions screens are displayed.

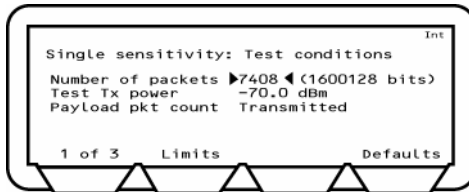

This screen lets you enter the number of packets to send and set the TX power.

4. Select "Number of packets".
5. Enter the number of packets using the keypad.
6. Select "Test TX power".
7. Enter the value required using the keypad.
8. Select "Payload Pkt count".

This setting allows the user to specify whether the count of the number of packets is based on the transmitted or received values. The settings are detailed below.

Transmitted: The count is based on the number of transmitted packets. Due to lost packets, this setting may result in failure to comply exactly with the *Bluetooth* test specification that requires that the test should be conducted for at least 1.6 million packets.

Received: The count is based on the number of packets actually received. This setting will force the MT8852B to continue testing until 1.6 million packets have actually been measured.

9. Press the **[1 of 3]** soft key to move to the second screen.

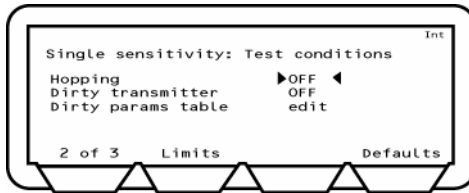

You can select how hopping is implemented. You can also switch the dirty transmitter On, Off, or On and Off. When the Dirty transmitter is switched on you can edit the Dirty parameter table.

10. Select "Hopping".
11. Press the **(Sel)** key to switch between ON, OFF and ON&OFF.
12. Select "Dirty transmitter".
13. Press the **(Sel)** key to switch between ON and OFF.
14. Select "Dirty params table edit".
15. Press the **(Sel)** key.

The Dirty parameters, Single sensitivity screen is displayed.

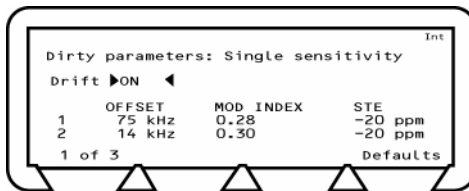

10 entries are displayed on three screens. The Drift selection is only available on the first screen. You can make changes to the OFFSET frequency values, MODULATION INDEX and SYMBOL TIMING ERROR (STE) shown.

16. Select "Drift" on screen 1 of 3.
17. Press the **(Sel)** key to switch between ON and OFF.

With Drift set to ON, the MT8852B transmits with a sine wave, frequency modulation, with a deviation of ± 25 kHz, rate 1.6 kHz, synchronised to zero phase at the packet start.

18. To change any of the OFFSET, MOD INDEX and STE, select the item, press the **(Sel)** key, enter the value using the keypad and press the **[Enter]** soft key.
19. Press the **(Back)** key to return to the Single sensitivity test conditions screen 2.

20. Press the **[2 of 3]** soft key to move to the third screen.

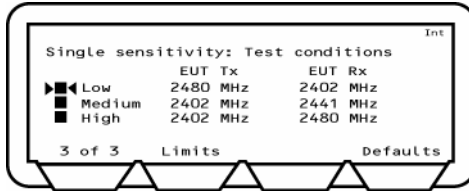

You can select or deselect the test to run and make changes to the frequency values shown.

21. To select or deselect a test, select the test and press the **[Sel]** key.
22. To change a frequency, select the frequency, press the **[Sel]** key, enter the value using the keypad and press the **[Enter]** soft key.
23. Press the **[Defaults]** soft key to restore the default values.
24. Press the **[Limits]** soft key to display the Single sensitivity test limits screen.

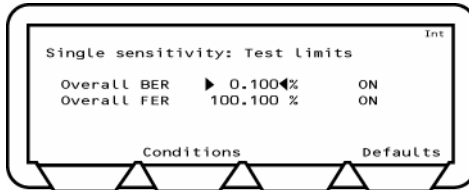

Note: As there is no RF Bluetooth specification for FER, the MT8852B defaults to a FER limit of 100%.

25. Press the **[Defaults]** soft key to restore the default values.
26. Select the limit you want to change.
27. Press the **[Sel]** key and enter the new limit using the keypad.
28. Press the **[Enter]** soft key.
29. Press the **[Conditions]** soft key to return to the test conditions screen.
30. Press the **[Back]** key to return to the Script menu.

Multi Slot Sensitivity Test (Standard Mode)

For a multi slot sensitivity measurement the MT8852B transmits the longest supported packet type as reported by the EUT during link set up with a pseudo random payload (PRBS 9) to the EUT at a minimum power level. If the dirty parameters are enabled then every 20 mS the MT8852B changes the transmitter parameters as specified in the dirty transmitter table for this test. The EUT loops back the received data and a bit error rate (BER) calculation and frame error rate (FER) calculation is performed by the MT8852B test set. This test is performed with hopping off. Measurements are made at each of the frequencies selected (LOW, MEDIUM and HIGH). The LOW, MEDIUM and HIGH frequencies relate to the default frequencies specified in the *Bluetooth* RF test specification. The MT8852B allows all the frequencies to be changed. This is the test method described in the *Bluetooth* RF Test Specification for a multi slot sensitivity test with hopping off.

The MT8852B can also carry out this test with hopping on.

1. Select "Multi sensitivity" from the standard measurements script menu.
2. Press the **Sel** key to select or deselect this test from the script routine.

If a test is selected, the box will be filled in. If not selected the box will be hollow.

3. Press the **[Setup]** soft key.

The Multi sensitivity test conditions screens are displayed.

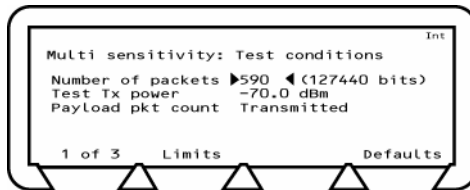

This screen lets you enter the number of packets to send and set the TX power.

4. Select "Number of packets".
5. Enter the number of packets using the keypad.
6. Select "Test TX power".
7. Enter the value required using the keypad.
8. Select "Payload Pkt count".

This setting allows the user to specify whether the count of the number of packets is based on the transmitted or received values. The settings are detailed below.

Transmitted: The count is based on the number of transmitted packets. Due to lost packets, this setting may result in failure to comply exactly with the *Bluetooth* test specification that requires that the test should be conducted for at least 1.6 million packets.

Received: The count is based on the number of packets actually received. This setting will force the MT8852B to continue testing until 1.6 million packets have actually been measured.

- Press the **[1 of 3]** soft key to move to the second screen.

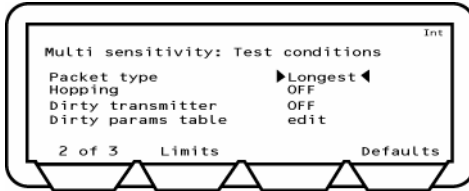

You can select how hopping is implemented. You can also switch the dirty transmitter On, Off, or On and Off. When the Dirty transmitter is switched on you can edit the Dirty parameter table.

- Select "Hopping".
- Press the **(Sel)** key to switch between ON, OFF and ON&OFF.
- Select "Dirty transmitter".
- Press the **(Sel)** key to switch between ON and OFF.
- Select "Dirty params table edit".
- Press the **(Sel)** key.

The Dirty parameters, Multi sensitivity screen is displayed.

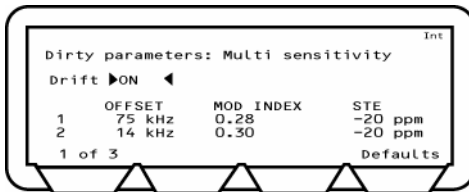

10 entries are displayed on three screens. The Drift selection is only available on the first screen. You can make changes to the OFFSET frequency values, MODULATION INDEX and SYMBOL TIMING ERROR (STE) shown.

- Select "Drift" on screen 1 of 3.
- Press the **(Sel)** key to switch between ON and OFF.

With Drift set to ON, the MT8852B transmits with a sine wave, frequency modulation, with a deviation of ± 25 kHz, rate 1.6 kHz, synchronised to zero phase at the packet start.

- To change any of the OFFSET, MOD INDEX and STE, select the item, press the **(Sel)** key, enter the value using the keypad and press the **[Enter]** soft key.
- Press the **(Back)** key to return to the Multi sensitivity test conditions screen 2.

20. Press the **[2 of 3]** soft key to move to the third screen.

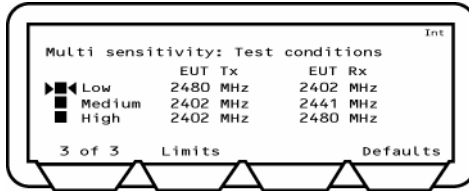

You can select or deselect the test to run and make changes to the frequency values shown.

21. To select or deselect a test, select the test and press the **[Sel]** key.
22. To change a frequency, select the frequency, press the **[Sel]** key, enter the value using the keypad and press the **[Enter]** soft key.
23. Press the **[Defaults]** soft key to restore the default values.
24. Press the **[Limits]** soft key to display the Multi sensitivity test limits screen.

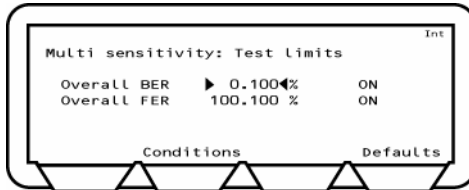

Note: As there is no RF Bluetooth specification for FER, the MT8852B defaults to a FER limit of 100%.

25. Press the **[Defaults]** soft key to restore the default values.
26. Select the limit you want to change.
27. Press the **[Sel]** key and enter the new limit using the keypad.
28. Press the **[Enter]** soft key.
29. Press the **[Conditions]** soft key to return to the test conditions screen.
30. Press the **[Back]** key to return to the Script menu.

Modulation Index Test (Standard Mode)

This test measures the modulation characteristics on the EUT output for each of the frequency ranges selected (LOW, MEDIUM and HIGH). The MT8852B can perform the test using either loopback test controls or TX test controls. The default form for this test is to use loopback. The following test is described using the default test control.

The MT8852B transmits a number of packets containing the four ones four zeros payload (11110000), which are looped back by the EUT. Then packets with the alternate ones and zeros (101010101) payload are transmitted and are looped back by the EUT. These packets are the longest supported packet type as reported by the EUT during link set up (DH1, DH3 or DH5) or the selected packet type.

This test is performed with hopping off, and the test is repeated until the number of packets has been measured on each of the selected frequencies as set in the "Number of packets" field. The LOW, MEDIUM and HIGH frequencies relate to the default frequencies specified in the *Bluetooth* RF test specification. The MT8852B allows all the frequencies to be changed.

When the test is performed in TX test mode EUT transmitter and receiver frequencies must be the same.

1. Select "Modulation index" from the standard measurements script menu.
2. Press the **Sel** key to select or deselect this test from the script routine.

If a test is selected, the box will be filled in. If not selected the box will be hollow.

3. Press the **[Setup]** soft key.

The Modulation index test conditions screens are displayed.

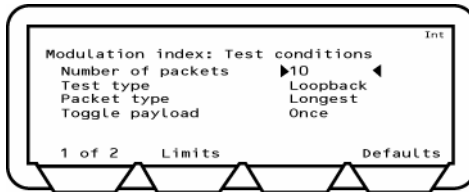

You can change the number of cycles, the test type and packet type.

4. Select "Number of packets".
5. Enter the value using the keypad.
6. Select "Test type".
7. Press the **Sel** key to switch between Loopback and TX.
8. Select "Packet type".
9. Press the **Sel** key to switch between Longest, DH1, DH3 or DH5.

10. Select “Toggle Payload” and select either “Continuous” or “Once” as detailed below.

Continuous: This is the default setting in which, to comply with the RF test specification, the payload is changed after each packet measured.

Once: This setting reduces the time required to complete the test. The payload is changed only once per measurement stage. The payload is changed after the selected number of packets has been measured with the first payload and the selected number of packets is then measured with the second payload.

11. Press the [1 of 2] soft key to move to the second screen.

The second screen will vary according to whether the Test type is in Loopback or TX mode. The following screen is in Loopback mode.

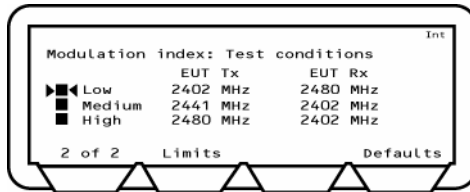

The following screen is in TX mode.

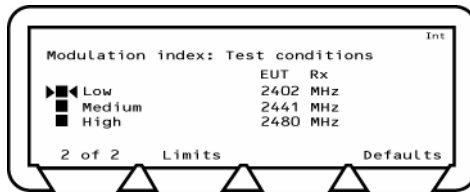

You can select or deselect the test to run and make changes to the frequency values shown.

12. To select or deselect a test, select the test and press the **[Sel]** key.
13. To change a frequency, select the frequency, press the **[Sel]** key, enter the value using the keypad and press the **[Enter]** soft key.
14. Press the **[Defaults]** soft key to restore the default values.
15. Press the **[Limits]** soft key to display the Modulation index test limits screen.

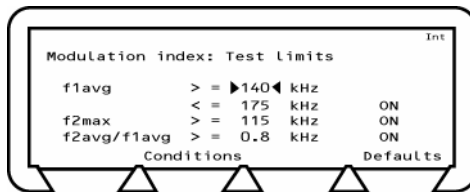

16. Press the **[Defaults]** soft key to restore the default values.
17. Select the limit you want to change.
18. Press the **[Sel]** key and enter the new limit using the keypad.

19. Press the **[Enter]** soft key.
20. Press the **[Conditions]** soft key to return to the test conditions screen.
21. Press the **[Back]** key to return to the Script menu.

Maximum Input Power Test (Standard Mode)

For the EUT maximum input power test the MT8852B transmits a pseudo random payload (PRBS 9) DH1 data packet to the EUT so that the EUT receives the signal at a power level of -20 dBm. The EUT loops back the received data and a bit error rate (BER) calculation and frame error rate (FER) calculation is performed by the MT8852B test set. The test is repeated for each of the frequency ranges selected (LOW, MEDIUM and HIGH). This test is performed with hopping off. The LOW, MEDIUM and HIGH frequencies relate to the default frequencies specified in the *Bluetooth* RF test specification. The MT8852B allows all the frequencies to be changed.

1. Select “Max input power” from the standard measurements script menu.
2. Press the **[Sel]** key to select or deselect this test from the script routine.
If a test is selected, the box will be filled in. If not selected the box will be hollow.
3. Press the **[Setup]** soft key.

The Maximum input power test conditions screens are displayed.

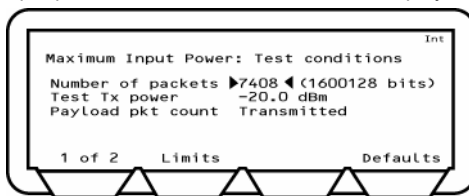

You can enter the number of packets to be sent and enter the Test transmission power value.

4. Select “Number of packets”, and press the **[Sel]** key.
5. Enter the number of packets from the keypad and press the **[Enter]** soft key.
6. Select “Test TX Power” and press the **[Sel]** key.
7. Enter the value from the keypad and press the **[Enter]** soft key.
8. Select “Payload Pkt count”.

This setting allows the user to specify whether the count of the number of packets is based on the transmitted or received values. The settings are detailed below.

Transmitted: The count is based on the number of transmitted packets. Due to lost packets, this setting may result in failure to comply exactly with the *Bluetooth* test specification that requires that the test should be conducted for at least 1.6 million packets.

Received: The count is based on the number of packets actually received. This setting will force the MT8852B to continue testing until 1.6 million packets have actually been measured.

9. Press the **[1 of 2]** soft key to move to the second screen.

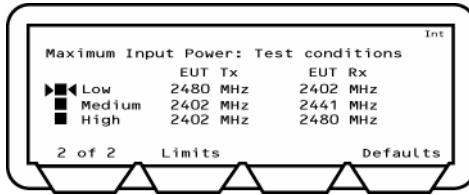

You can select or deselect the test to run and make changes to the frequency values shown.

10. To select or deselect a test, select the test and press the **(Sel)** key.
11. To change a frequency, select the frequency, press the **(Sel)** key, enter the value using the keypad and press the **[Enter]** soft key.
12. Press the **[Defaults]** soft key to restore the default values.
13. Press the **[Limits]** soft key to display the Maximum input power test limits screen.

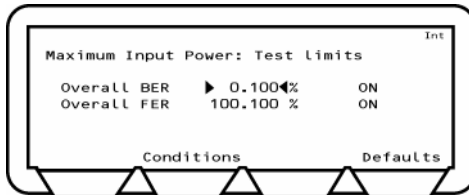

Note: The Bluetooth specification does not detail the FER value, so the customer can set a percentage pass level to meet their own requirements.

14. Press the **[Defaults]** soft key to restore the default values.
15. Select the limit you want to change.
16. Press the **(Sel)** key and enter the new limit using the keypad.
17. Press the **[Enter]** soft key.
18. Press the **[Conditions]** soft key to return to the test conditions screen.
19. Press the **(Back)** key to return to the Script menu.

Relative Tx Power Test (Standard Mode)

The EDR relative transmit power measurement ensures that the difference in average transmit power during the frequency modulated [GFSK] and phase modulated [PSK] parts of a packet is within the range specified below.

Pass criteria = (PGFSK - 4dB) < PDPSK < (PGFSK + 1dB)

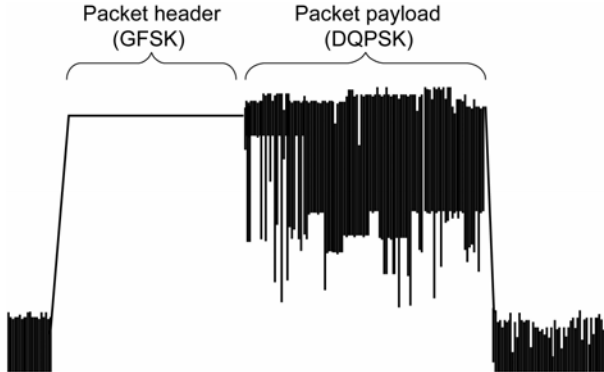

The test can be performed using either Loopback or TX mode test controls with hopping on or off. If the EUT supports both $\pi/4$ DQPSK and 8DPSK modulation, then the test must be performed on both modulation formats using the longest support packet type.

The test must be performed with the EUT transmitting at its maximum power, and if the EUT supports power control, also at its minimum transmitter power level. The MT8852B will set the EUT to the Max and Min transmit power automatically if the EUT reports that it supports power control and both Max and Min have been selected in the “EUT power level” entry field.

1. Select “Rel Tx Power” from the EDR measurements script menu.
2. Press the **[Sel]** key to select or deselect this test from the script routine.
If a test is selected, the box will be filled in. If not selected the box will be hollow.
3. Press the **[Setup]** soft key.

The EDR Rel Tx Power test conditions screens are displayed.

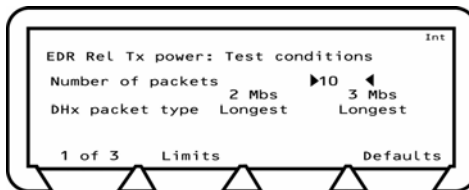

4. Select “Number of packets”, and press the **[Sel]** key.
5. Enter the number of packets from the keypad and press the **[Enter]** soft key.
6. Select “DHx packet type” and press the **[Sel]** key to toggle between the five settings available.

7. Press the **[1 of 3]** soft key to move to the second screen.

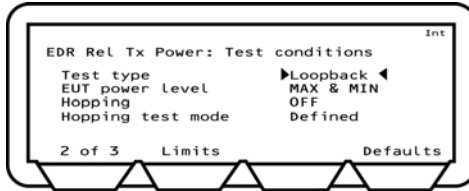

8. Select "Test type" and press the **[Sel]** key to switch between Loopback and Tx mode.
9. Select "EUT power level" and press the **[Sel]** key to toggle between "MAX", "MIN", and "MAX & MIN". The "MAX" and "MIN" settings set the EUT to its maximum or minimum power respectively. If "MAX & MIN" is selected, the EUT is set initially to its maximum power and testing is then repeated after resetting the EUT to its minimum power.
10. Select "Hopping" and press the **[Sel]** key to switch between ON, OFF and ON&OFF.
11. If hopping was set to a setting other than "OFF", select "Hopping test mode" and press the **[Sel]** key to switch between "All", "Any" or "Defined".
12. Press the **[2 of 3]** soft key to move to the third screen.

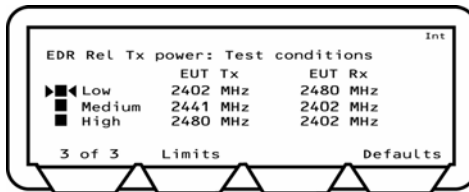

13. Press the **[Sel]** key to select or deselect a frequency for testing.
14. To change a frequency, select the frequency, press the **[Sel]** key, enter the value using the keypad and press the **[Enter]** soft key.
15. Press the **[Limits]** soft key to display the Relative Tx power test limits screen.
16. Select the limit you want to change, press the **[Sel]** key and enter the new limit using the keypad.
17. Press the **[Enter]** soft key. If required, the value can be restored to the default setting by pressing the **[Defaults]** soft key.
18. Press the **[Conditions]** soft key to return to the test conditions screen.
19. Press the **[Back]** key to return to the Script menu.

Carrier & Modulation Test (Standard Mode)

This test verifies the transmitter carrier frequency stability and modulation accuracy. The test comprises of both a frequency measurement and a Differential Error Vector Magnitude (DEV M) measurement. The frequency measurements defined are:-

- Initial frequency error of the packet header which is GFSK modulated - ω_i (Pass criteria $\pm 75\text{kHz}$)
- Block frequency error during $50\mu\text{s}$ time blocks in the PSK modulated payload - ω_0 (pass criteria $\pm 10\text{kHz}$) This frequency error is measured relative to the Initial frequency error. The MT8852B continues to measure packets until the user selected number of $50\mu\text{s}$ blocks has been tested, the default being 200 blocks.
- It is also a requirement of the test that the sum of the above 2 tests ($\omega_i + \omega_0$) does not exceed $\pm 75\text{kHz}$

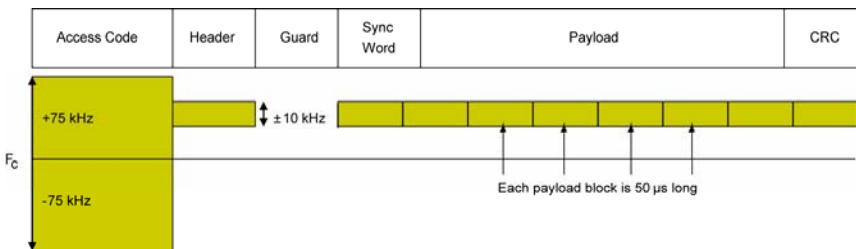

The modulation measurements defined are;

- RMS DEV M. This is the average DEV M for all the symbols in each $50\mu\text{s}$ block measured. The result is calculated for each block, and each block must pass the following criteria, ≤ 0.20 for all $\pi/4\text{DQPSK}$ blocks and ≤ 0.13 for all 8DPSK blocks.
- Peak DEV M. This is the DEV M value of the single symbol in all the blocks measured that has the highest value. The pass criterion is ≤ 0.35 for all $\pi/4\text{DQPSK}$ symbols and ≤ 0.25 for all 8DPSK symbols.
- 99% DEV M. This is the percentage of symbols measured in all the blocks that pass the following limit. The pass criterion is 99% of all symbols are ≤ 0.30 for all $\pi/4\text{DQPSK}$ symbols, and 99% of all symbols are ≤ 0.20 for all 8DPSK symbols.

The default criteria for this measurement is that the longest supported $\pi/4\text{DQPSK}$ and the longest support 8DPSK packets must both be tested in loopback mode with hopping off.

1. Select "Carrier & mod" from the EDR measurements script menu.
2. Press the **Sel** key to select or deselect this test from the script routine.

If a test is selected, the box will be filled in. If not selected the box will be hollow.

3. Press the **[Setup]** soft key.

The EDR carrier & modulation test conditions screens are displayed.

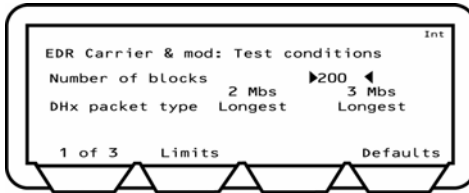

4. Select “Number of blocks”, and press the **Sel** key. Enter the number of blocks from the keypad and press the **[Enter]** soft key.
5. Select “DHx packet type” and press the **Sel** key to toggle between the five settings available for both the 2 and 3 Mbs settings.
6. Press the **[1 of 3]** soft key to move to the second screen.

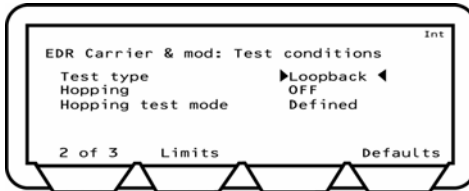

7. Select “Test type” and press the **Sel** key to switch between Loopback and Tx mode.
8. Select “Hopping” and press the **Sel** key to switch between ON, OFF and ON&OFF.
9. If hopping was set to a setting other than “OFF”, select “Hopping test mode” and press the **Sel** key to switch between “All”, “Any” or “Defined”.
10. Press the **[2 of 3]** soft key to move to the third screen.

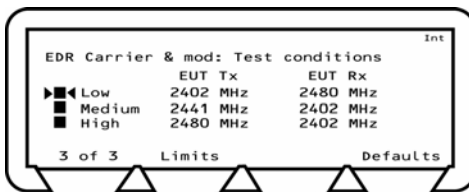

11. Press the **Sel** key to select or deselect a frequency for testing.
12. To change a frequency, select the frequency, press the **Sel** key, enter the value using the keypad and press the **[Enter]** soft key.
13. Press the **[Limits]** soft key to display the Relative Tx power test limits screen.
14. Select the limit you want to change, press the **Sel** key and enter the new limit using the keypad.
15. Press the **[Enter]** soft key. If required, the value can be restored to the default setting by pressing the **[Defaults]** soft key.
16. Press the **[Conditions]** soft key to return to the test conditions screen.
17. Press the **[Back]** key to return to the Script menu.

Differential Phase Test (Standard Mode)

In this measurement the EUT transmits a packet with a defined PRBS9 payload. The payload of the received packet is demodulated and compared with the defined ideal packet to give a resultant symbol error rate. The Bluetooth 2.0 specification stipulates that zero errors are detected in 99% of 100 packets transmitted.

The Bluetooth test specification only requires this test to be performed on 2-DH1 and 3-DH1 packets on channel 0.

1. Select "Diff Phase" from the EDR measurements script menu.
2. Press the **[Sel]** key to select or deselect this test from the script routine.
If a test is selected, the box will be filled in. If not selected the box will be hollow.
3. Press the **[Setup]** soft key.

The EDR Diff Phase test conditions screens are displayed.

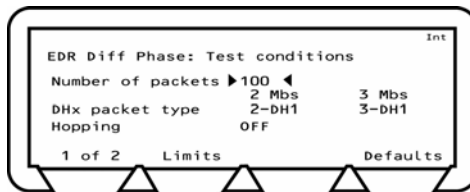

4. Select "Number of packets", and press the **[Sel]** key.
5. Enter the number of packets from the keypad and press the **[Enter]** soft key.
6. Select "Hopping" and press the **[Sel]** key to switch between ON, OFF and ON&OFF.
7. Press the **[1 of 2]** soft key to move to the third screen.

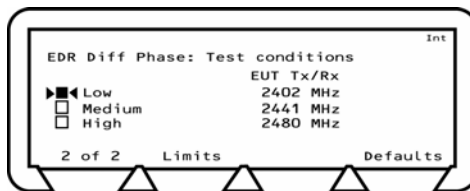

8. Press the **[Sel]** key to select or deselect a frequency for testing.
9. To change a frequency, select the frequency, press the **[Sel]** key, enter the value using the keypad and press the **[Enter]** soft key.
10. Press the **[Limits]** soft key to display the Relative Tx power test limits screen.
11. Select the limit you want to change, press the **[Sel]** key and enter the new limit using the keypad.
12. Press the **[Enter]** soft key. If required, the value can be restored to the default setting by pressing the **[Defaults]** soft key.
13. Press the **[Conditions]** soft key to return to the test conditions screen.
14. Press the **[Back]** key to return to the Script menu.

EDR Sensitivity Test (Standard Mode)

The sensitivity test case is to test the EUT receiver sensitivity performance in terms of bit error rate using a non-ideal (dirty) test signal. The test should be performed on the longest supported $\pi/4$ DQPSK and 8DPSK packets with frequency hopping off.

The signal source level is set so that the EUT receiver has an input level of -70dBm with defined signal impairments. At each of the test frequencies, the tester transmits packets to the EUT. The EUT loops back the packets to the tester until the tester has received 1,600,000 bits. If the BER measured is $\leq 7 \times 10^{-5}$ then the test has passed and the test stops. If the BER is $\geq 7 \times 10^{-5}$ then the test continues until the tester has received 16,000,000 bits. If the BER measured is $\leq 1 \times 10^{-4}$ then the EUT has passed. This pass criteria applies to each test frequency.

1. Select "EDR Sensitivity" from the EDR measurements script menu.
2. Press the **Sel** key to select or deselect this test from the script routine.

If a test is selected, the box will be filled in. If not selected the box will be hollow.

3. Press the **[Setup]** soft key.

The EDR sensitivity test conditions screens are displayed.

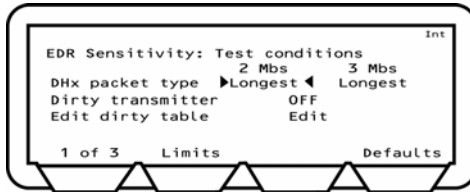

4. Select "DHx packet type" and press the **Sel** key to toggle between the five settings available for both the 2 and 3 Mbs settings.
5. Select "Dirty transmitter", and press the **Sel** key to toggle between "ON" and "OFF".
6. Select "Edit dirty table" and press the **Sel** key.

The Dirty parameters, EDR sensitivity screen is displayed.

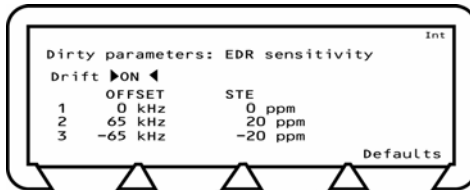

7. Select "Drift" and press the **Sel** key to switch between ON and OFF.

With Drift set to ON, the MT8852B transmits with a sine wave, frequency modulation, with a deviation of ± 25 kHz, rate 1.6 kHz, synchronised to zero phase at the packet start.

8. To change any of the OFFSET frequency values or symbol timing error rates (STE) press the **Sel** key, enter the value using the keypad and press the **[Enter]** soft key.
9. Press **Back** to return to the previous page and then press the **[1 of 3]** soft key to move to the second screen.

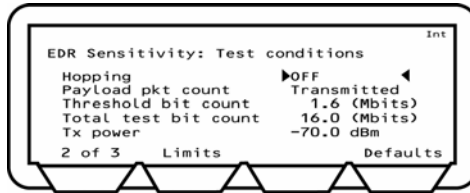

10. Select "Hopping" and press the **Sel** key to switch between ON, OFF and ON&OFF.
11. Select "Payload Pkt count".

This setting allows the user to specify whether the count of the number of packets is based on the transmitted or received values. The settings are detailed below.

Transmitted: The count is based on the number of transmitted packets. Due to lost packets, this setting may result in failure to comply exactly with the *Bluetooth* test specification that requires that the test should be conducted for at least 1.6 million packets.

Received: The count is based on the number of packets actually received. This setting will force the MT8852B to continue testing until 1.6 million packets have actually been measured.

12. Select "Threshold bit count", press **Sel** and enter a value from the keypad.
13. Select "Total test bit count", press **Sel** and enter a value from the keypad.
14. Select "Tx power", press **Sel** and enter a value from the keypad.
15. Press the **[2 of 3]** soft key to move to the third screen.

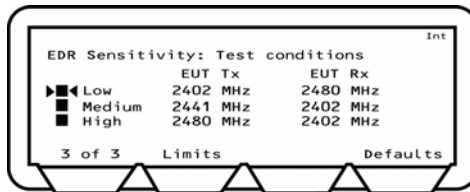

16. Press the **Sel** key to select or deselect a frequency for testing.
17. To change a frequency, select the frequency, press the **Sel** key, enter the value using the keypad and press the **[Enter]** soft key.
18. Press the **[Limits]** soft key to display the Relative Tx power test limits screen.
19. Select the limit you want to change, press the **Sel** key and enter the new limit using the keypad.
20. Press the **[Enter]** soft key. If required, the value can be restored to the default setting by pressing the **[Defaults]** soft key.
21. Press the **[Conditions]** soft key to return to the test conditions screen.
22. Press the **Back** key to return to the Script menu.

EDR BER Floor Test (Standard Mode)

The BER floor performance test case is to test whether the EUT receiver sensitivity has low residual BER performance when tested at a level 10dB above its minimum sensitivity. The test should be performed on the longest supported $\pi/4$ DQPSK and 8DPSK packets with frequency hopping off.

The signal source level is set so that the EUT receiver has an input level of -60dBm with no signal impairments. At each of the test frequencies, the tester transmits packets to the EUT. The EUT loops back the packets to the tester until the tester has received 8,000,000 bits. If the BER measured is $\leq 7 \times 10^{-6}$ then the test has passed and the test stops. If the BER is $\geq 7 \times 10^{-5}$ then the test continues until the tester has received 160,000,000 bits. If the BER measured is $\leq 1 \times 10^{-5}$ then the EUT has passed. This pass criteria applies to each test frequency.

1. Select “EDR BER floor” from the EDR measurements script menu.
2. Press the **[Sel]** key to select or deselect this test from the script routine.

If a test is selected, the box will be filled in. If not selected the box will be hollow.

3. Press the **[Setup]** soft key.

The EDR BER floor test conditions screens are displayed.

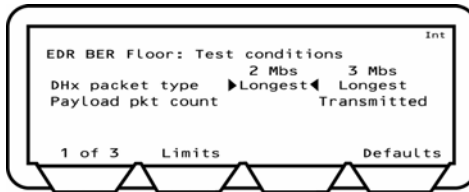

4. Select “DHx packet type” and press the **[Sel]** key to toggle between the five settings available for both the 2 and 3 Mbs settings.
5. Select “Payload Pkt count”.

This setting allows the user to specify whether the count of the number of packets is based on the transmitted or received values. The settings are detailed below.

Transmitted: The count is based on the number of transmitted packets. Due to lost packets, this setting may result in failure to comply exactly with the *Bluetooth* test specification that requires that the test should be conducted for at least 1.6 million packets.

Received: The count is based on the number of packets actually received. This setting will force the MT8852B to continue testing until 1.6 million packets have actually been measured.

6. Press the **[1 of 3]** soft key to move to the second screen.

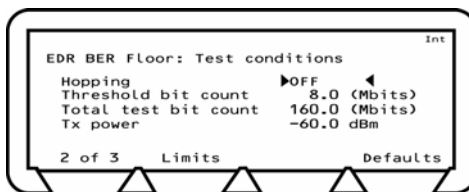

7. Select "Hopping" and press the **Sel** key to switch between ON, OFF and ON&OFF.
8. Select "Threshold bit count", press **Sel** and enter a value from the keypad.
9. Select "Total test bit count", press **Sel** and enter a value from the keypad.
10. Select "Tx power", press **Sel** and enter a value from the keypad.
11. Press the **[2 of 3]** soft key to move to the third screen.

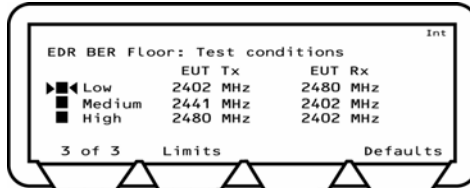

12. Press the **Sel** key to select or deselect a frequency for testing.
13. To change a frequency, select the frequency, press the **Sel** key, enter the value using the keypad and press the **[Enter]** soft key.
14. Press the **[Limits]** soft key to display the Relative Tx power test limits screen.
15. Select the limit you want to change, press the **Sel** key and enter the new limit using the keypad.
16. Press the **[Enter]** soft key. If required, the value can be restored to the default setting by pressing the **[Defaults]** soft key.
17. Press the **[Conditions]** soft key to return to the test conditions screen.
18. Press the **[Back]** key to return to the Script menu.

EDR Max Input Test (Standard Mode)

The EDR Maximum input level test case is to test whether the EUT receiver sensitivity has low BER performance when tested at a high signal level close to its maximum specified input. The test should be performed on the longest supported $\pi/4$ DQPSK and 8DPSK packets with frequency hopping off.

The signal source level is set so that the EUT receiver has an input level of -20dBm with no signal impairments. At each of the test frequencies, the tester transmits packets to the EUT. The EUT loops back the packets to the tester until the tester has received 1,600,000 bits. The pass criterion is that the EUT BER shall be $\leq 1 \times 10^{-3}$. This pass criterion applies to each test frequency.

1. Select “EDR Max input level” from the EDR measurements script menu.
2. Press the **Sel** key to select or deselect this test from the script routine.
If a test is selected, the box will be filled in. If not selected the box will be hollow.
3. Press the **[Setup]** soft key.

The EDR max input level test conditions screens are displayed.

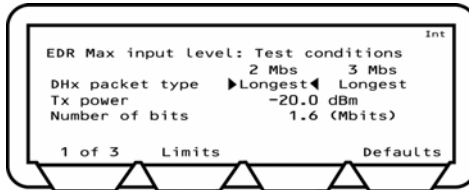

4. Select “DHx packet type” and press the **Sel** key to toggle between the five settings available for both the 2 and 3 Mbs settings.
5. Select “Tx power”, press **Sel** and enter a value from the keypad.
6. Select “Number of bits”, press **Sel** and enter a value from the keypad.
7. Press the **[1 of 3]** soft key to move to the second screen.

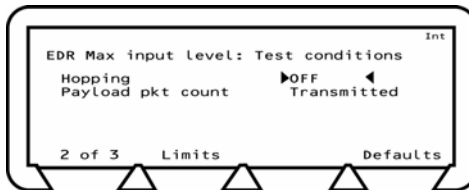

8. Select “Hopping” and press the **Sel** key to switch between ON, OFF and ON&OFF.
9. Select “Payload Pkt count”.

This setting allows the user to specify whether the count of the number of packets is based on the transmitted or received values. The settings are detailed below.

Transmitted: The count is based on the number of transmitted packets. Due to lost packets, this setting may result in failure to comply exactly with the *Bluetooth* test specification that requires that the test should be conducted for at least 1.6 million packets.

Received: The count is based on the number of packets actually received. This setting will force the MT8852B to continue testing until 1.6 million packets have actually been measured.

10. Press the **[2 of 3]** soft key to move to the third screen.

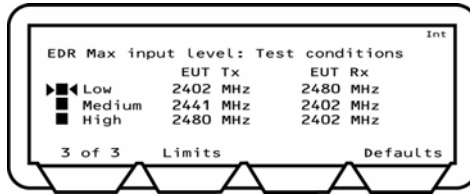

11. Press the **[Sel]** key to select or deselect a frequency for testing.
12. To change a frequency, select the frequency, press the **[Sel]** key, enter the value using the keypad and press the **[Enter]** soft key.
13. Press the **[Limits]** soft key to display the Relative Tx power test limits screen.
14. Select the limit you want to change, press the **[Sel]** key and enter the new limit using the keypad.
15. Press the **[Enter]** soft key. If required, the value can be restored to the default setting by pressing the **[Defaults]** soft key.
16. Press the **[Conditions]** soft key to return to the test conditions screen.
17. Press the **[Back]** key to return to the Script menu.

Testing in Single Payload Script Mode

In single payload mode the MT8852B sends a single test control to put the EUT into the specified state, and no further test controls are sent. When single payload mode is specified, an additional “single payload edit” line displays on the screen. Move the cursor to the word [Edit] and press the **[Sel]** key. The required settings to enable each test are detailed in the test procedures below.

Output Power Test (Single Payload Mode)

The MT8852B can perform the test using either loopback test controls or TX test controls. The default for this test is to use loopback. The following test description is described using the default test control.

The MT8852B transmits a pseudo random data payload (PRBS 9) of the longest supported type (DH5, DH3 or DH1) or the selected packet type, to the EUT. The EUT loops back the data at its maximum output power and the MT8852B measures the received power.

1. Refer to the settings below to enable the output power test in the script menu.
 Test control: TX or Loopback
 Payload: Any
 Packet type: Any
 Hopping mode: On or Off
2. Select “Output power” from the Script menu.
3. Press the **[Sel]** key to select or deselect this test from the script routine.
4. If a test is selected, the box will be filled in. If not selected the box will be hollow.
5. Press the **[Setup]** soft key.
6. The Output power test limits screen is displayed.

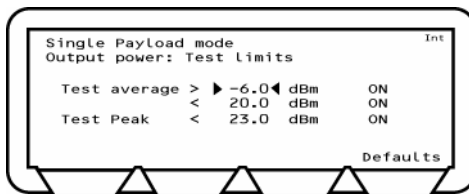

7. Press the **[Defaults]** soft key to restore the default values.
8. Select the limit you want to change.
9. Press the **[Sel]** key and enter the new limit using the keypad.
10. Press the **[Enter]** soft key.
11. Press the **[Back]** key to return to the Script menu.

Power control test (single payload mode)

The power control test is not supported in single payload mode.

Initial Carrier Test (Single Payload Mode)

The initial carrier test performs a frequency accuracy test on a DH1 pseudo random data packet. (PRBS 9) This test can be performed using either the loopback test control or the TX test control. The default is to use the loopback test control. This test can be made with either hopping on or off.

1. Refer to the settings below to enable the initial carrier test in the test list.
Test control: TX or Loopback
Payload: Any
Packet type: Any
Hopping mode: On or Off
2. Select "Init carrier" from the Script menu.
3. Press the **Sel** key to select or deselect this test from the script routine.
4. If a test is selected, the box will be filled in. If not selected the box will be hollow.
5. Press the **[Setup]** soft key.
6. The Initial carrier test limits screen is displayed.

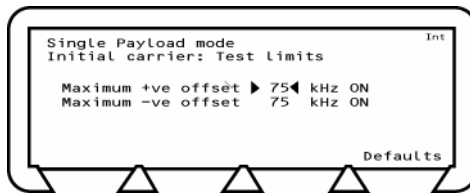

7. Press the **[Defaults]** soft key to restore the default values.
8. Select the limit you want to change.
9. Press the **Sel** key and enter the new limit using the keypad.
10. Press the **[Enter]** soft key.
11. Press the **Back** key to return to the Script menu.

Carrier Drift Test (Single Payload Mode)

The carrier drift test performs a frequency drift measurement over the length of the packet received. This test can be performed using either the loopback test control or the TX test control. The default is to use the loopback test control.

In loopback mode with hopping off, the MT8852B sends a packet with a 10101010 and the EUT returns packet for measurement.

In TX mode with hopping on or off, the measurement process is the same as for loopback except that the MT8852B does not send full DHX packets but just POLL packets. The EUT has been configured by the MT8852B to respond to a POLL with the appropriate DHX packet. The EUT must support TX mode part of the Test Mode specification for this to work. The test time is much shorter when run using TX mode compared with loopback, as the MT8852B does not have to send full packet lengths. When the test is performed in TX test mode, EUT transmitter and receiver frequencies must be the same. For this test, the TX and RX frequencies are the same. TX mode complies with the *Bluetooth* RF Test Specification for a carrier frequency drift test.

1. Refer to the settings below to enable the carrier drift test in the test list.
 Test control: TX or Loopback
 Payload: 10101010
 Packet type: Any
 Hopping mode: On or Off
2. Select "Carrier drift" from the Script menu.
3. Press the **[Sel]** key to select or deselect this test from the script routine.
4. If a test is selected, the box will be filled in. If not selected the box will be hollow.
5. Press the **[Setup]** soft key to display the Carrier drift test limits screen.

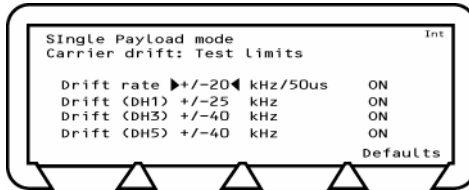

6. Press the **[Defaults]** soft key to restore the default values.
7. Select the limit you want to change.
8. Press the **[Sel]** key and enter the new limit using the keypad.
9. Press the **[Enter]** soft key.
10. Press the **[Back]** key to return to the Script menu.

Single Slot Sensitivity Test (Single Payload Mode)

For a single slot sensitivity measurement the MT8852B transmits a DH1 packet with a pseudo random payload (PRBS 9) to the EUT at a minimum power level. This test can be performed with hopping on or off.

1. Refer to the settings below to enable the single slot sensitivity test in the test list.
Test control: Loopback
Payload: PRBS9
Packet type: DH1
Hopping mode: On or Off
2. Select "Single sensitivity" from the Script menu.
3. Press the **Sel** key to select or deselect this test from the script routine.
4. If a test is selected, the box will be filled in. If not selected the box will be hollow.
5. Press the **[Setup]** soft key.
6. The Single sensitivity test limits screen is displayed.

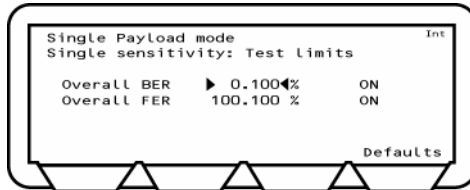

7. Press the **[Defaults]** soft key to restore the default values.
8. Select the limit you want to change.
9. Press the **Sel** key and enter the new limit using the keypad.
10. Press the **[Enter]** soft key.
11. Press the **Back** key to return to the Script menu.

Multi-Slot Sensitivity Test (Single Payload Mode)

For a multi slot sensitivity measurement the MT8852B transmits the longest supported packet type as reported by the EUT during link set up with a pseudo random payload (PRBS 9) to the EUT at a minimum power level. The EUT loops back the received data and a bit error rate (BER) calculation and frame error rate (FER) calculation is performed by the MT8852B test set. This test can be performed with hopping on or off.

1. Refer to the settings below to enable the multi-slot sensitivity test in the test list.
 Test control: Loopback
 Payload: PRBS9
 Packet type: DH3 or DH5
 Hopping mode: On or Off
2. Select "Multi sensitivity" from the Script menu.
3. Press the **Sel** key to select or deselect this test from the script routine.
4. If a test is selected, the box will be filled in. If not selected the box will be hollow.
5. Press the **[Setup]** soft key.
6. The Multi sensitivity test limits screen.

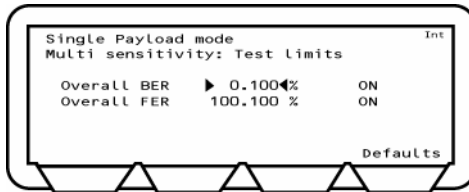

7. Press the **[Defaults]** soft key to restore the default values.
8. Select the limit you want to change.
9. Press the **Sel** key and enter the new limit using the keypad.
10. Press the **[Enter]** soft key.
11. Press the **Back** key to return to the Script menu.

Modulation Index Test (Single Payload Mode)

The MT8852B can perform this test using either loopback test controls or TX test controls. The default form for this test is to use loopback. The following test is described using the default test control.

The MT8852B transmits a packet that is looped back by the EUT. These packets are the longest supported packet type as reported by the EUT during link set up (DH1, DH3 or DH5) or the selected packet type.

When the test is performed in TX test mode, EUT transmitter and receiver frequencies must be the same.

1. Refer to the settings below to enable the modulation index test in the test list.
 Test control: TX or Loopback
 Payload: 10101010 or 11110000
 Packet type: Any
 Hopping mode: Off
2. Select "Modulation index" from the Script menu.
3. Press the **Sel** key to select or deselect this test from the script routine.
4. If a test is selected, the box will be filled in. If not selected the box will be hollow.
5. Press the **[Setup]** soft key.
6. The Modulation index test limits screen displays.

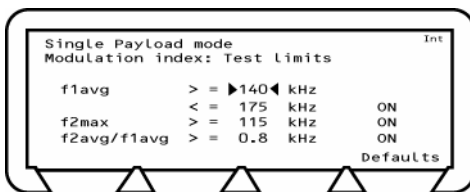

7. Press the **[Defaults]** soft key to restore the default values.
8. Select the limit you want to change.
9. Press the **Sel** key and enter the new limit using the keypad.
10. Press the **[Enter]** soft key.
11. Press the **Back** key to return to the Script menu.

Maximum input power test (single payload mode)

The maximum input power test is not supported in single payload mode.

Entering the BT Address of the EUT

The address of the equipment under test can be entered manually from the keyboard, acquired by performing an inquiry, or obtained through the RS232 HCI port. For the MT8852B, the address can also be acquired through the USB HCI port.

1. With the Script menu displayed, press the **[EUT addr]** soft key.

The EUT address screen is displayed.

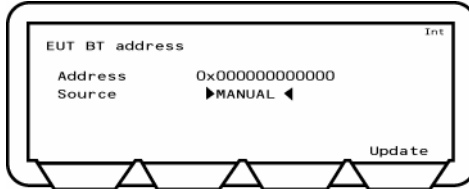

At power up when the source is RS232, "No address" will be displayed.

2. Press the **[Update]** soft key to display the EUT.

To change the source and enter the address:

1. Select "Source" and press the **[Sel]** key to switch between RS232, Manual, Inquiry, and USB (MT8852B only).
2. **For manual**, press the **[Update]** soft key and enter the hexadecimal address for EUT from the keypad. Alternatively, select the Address field, press the Select key and enter the hexadecimal address for EUT from the keypad.
3. **For Inquiry**, press the **[Update]** soft key to initiate the Inquiry.

Note: If the number of responses for the inquiry is set to 1, the MT8852B will automatically connect to the first device that responds.

4. Press the **[Stop]** soft key to halt the Inquiry.

The Inquiry completed screen is displayed.

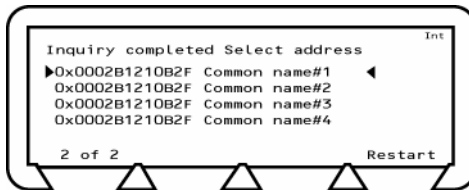

The Common name is the user-friendly name truncated to fit the line on the screen. You can restart the Inquiry using the **[Restart]** soft key.

5. Select the address required and press the **[Sel]** key to enter the address.

Viewing Test Results

The results screens show pass or fail results for test limits set to ON. These screens are for information only and cannot be changed.

The results screens detailed below apply for each of the script mode settings (standard, single payload, and null packet) unless otherwise stated.

Output Power Test Results

1. Select "Output power" from the Script menu.
2. Press the **[Results]** soft key.

The Output power results screen is displayed.

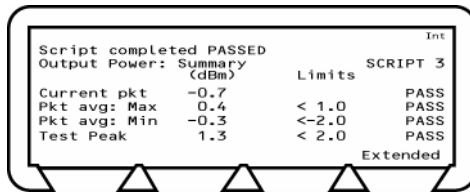

Definition of test results

- Current Pkt** Displays the average power of the last packet measured by the MT8852B. The MT8852B identifies the p0 in the packet and measures the power in each individual bit. Packet avg is the average power of all the measured bits.
- Pkt Avg; Max** Displays the highest power measured of all of the Packet avg measurements during the test.
- Pkt Avg; Min** Displays the lowest power measured of all of the Packet avg measurements during the test.
- Test peak** This is the power of the single bit in the packet that has the greatest power. The value displayed is the largest peak power measured for all packets in the test.

3. Press the **[Extended]** soft key to display more detailed test results. As opposed to the summary screen shown above, the extended screens are specific to each of the test scenarios. For example, if a test is performed at high, medium, and low frequencies, with hopping both on and off, there would be six extended screens. An example of the first extended screen for the output power test is shown below.

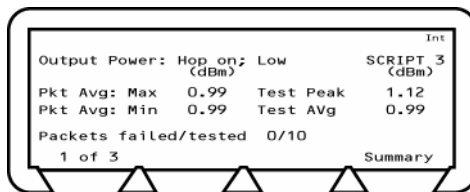

4. Page through the extended screens with the soft key in the normal manner, or press the **[Summary]** soft key to revert to the initial summary page.

Power Control Test Results

1. Select “Power control” from the Script menu.
2. Press the **[Results]** soft key.

The Power control results screen is displayed.

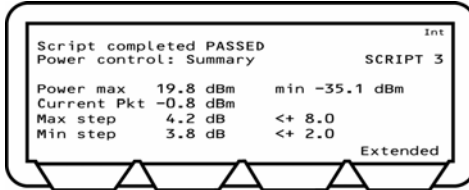

Definition of test results

- Power max Displays the maximum power the EUT has risen to in the test.
- Power min Displays the minimum power the EUT has dropped to in the test.
- Current Pkt Displays the average power of the last packet measured by the MT8852B. The MT8852B identifies the p0 in the packet and measures the power in each individual bit. Packet avg is the average power of all the measured bits.
- Max step Displays the largest change between the power level steps.
- Min step Display the smallest change between the power level steps.

3. Press the **[Extended]** soft key to display more detailed test results. As opposed to the summary screen shown above, the extended screens are specific to each frequency.

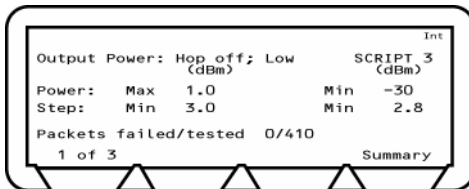

4. Page through the extended screens with the soft key in the normal manner, or press the **[Summary]** soft key to revert to the initial summary page.

Single payload and null packet modes

This test cannot be performed in single payload or null packet modes.

Initial Carrier Test Results

1. Select "Init carrier" from the Script menu.
2. Press the **[Results]** soft key.

The Initial carrier results screens are displayed.

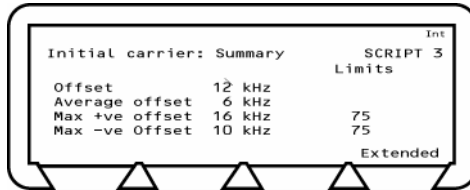

Definition of test results

- Offset** Displays the initial frequency error of the last packet measured.
- Average offset** Displays the average value of all initial frequency offset measurements made in the test.
- Max +ve offset** Displays the frequency error of the single packet that had the greatest positive error of all those measured.
- Max -ve offset** Displays the frequency error of the single packet that had the greatest negative error of all those measured.

3. Press the **[Extended]** soft key to display more detailed test results. As opposed to the summary screen shown above, the extended screens are specific to each of the test scenarios. For example, if a test is performed at high, medium, and low frequencies, with hopping both on and off, there would be six extended screens. An example of the first extended screen for the initial carrier test is shown below.

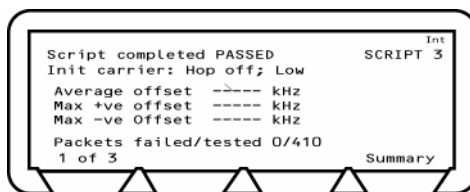

4. Page through the extended screens with the soft key in the normal manner, or press the **[Summary]** soft key to revert to the initial summary page.

Carrier Drift Test Results

Standard and single packet modes

1. Select "Carrier drift" from the Script menu.
2. Press the **[Results]** soft key.

The Carrier drift results screen is displayed.

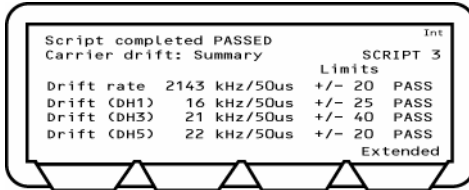

Definition of test results

Drift rate Displays the maximum drift rate between any two 10-bit groups in the packet, separated by 50µs. This value is the peak held worst case value for packets measured during the test.

Drift (DHX) Displays the difference between the average frequency of the first 4 preamble bits of the packet and the average frequency of any 10 bits in the payload field of the same packet. This value is the peak held worst case value for packets measured during the test.

3. Press the **[Extended]** soft key to display more detailed test results. As opposed to the summary screen shown above, the extended screens are specific to each of the test scenarios. For example, if a test is performed at high, medium, and low frequencies, with hopping both on and off, there would be six extended screens. An example of the first extended screen for the carrier drift test is shown below.

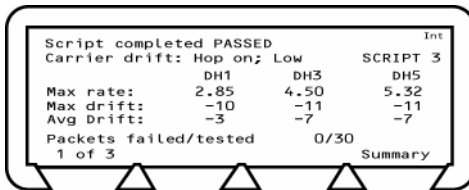

Note: "Packets Tested" refers to the total of all packets tested (i.e., at DH1, DH3, and DH5)

4. Page through the extended screens with the soft key in the normal manner, or press the **[Summary]** soft key to revert to the initial summary page.

Null packet mode

In null packets mode the carrier drift results screen displays as follows.

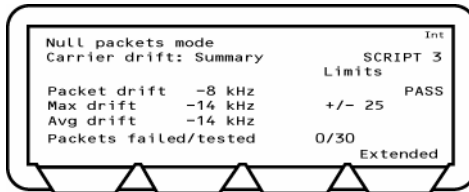

Definition of test results

Avg drift Displays the average drift over the entire test.

Max drift Displays the peak hold value of the worst recorded drift.

It should be noted that in null packets mode, drift refers to the frequency difference between the preamble and the trailer.

Single Slot Sensitivity Results

Standard and single packet modes

1. Select “Single sensitivity” from the Script menu.
2. Press the **[Results]** soft key.

The Single sensitivity results screens are displayed.

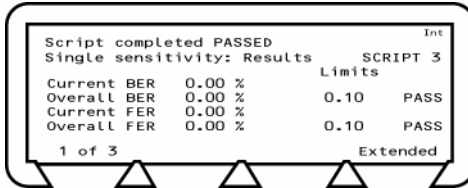

3. Press the **[1 of 3]** soft key to move to the second screen.

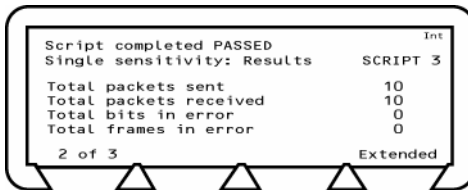

4. Press the **[2 of 3]** soft key to move to the third screen.

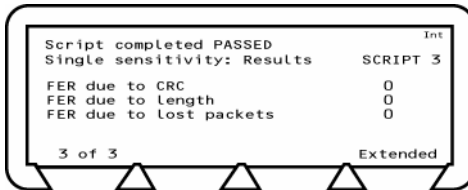

Definition of test results

- Current BER Displays the BER as measured in the last 10 returned packets.
- Overall BER Displays the BER for all the returned packets.
- Current FER Displays the FER as measured in the last 10 returned packets.
- Overall FER Displays the FER for all the returned packets.
- FER due to CRC Displays the number of packets returned that had a CRC error. These packets are used in BER calculations.
- FER due to length Displays the number of packets returned where the payload length of the packet was incorrect. This will also result in a CRC error. These packets are used in BER calculations.
- FER due to lost packets A lost packet will result from the MT8852B:
 - Not recognising the sync word header as being correct.

- The packet fails the Header Error Correction (HEC)
- No packet received at all during the expected time slot.
- NACK packet is received.

These packets are not used in BER calculations.

5. Press the **[Extended]** soft key to display more detailed test results. As opposed to the summary screen shown above, the extended screens are specific to each of the test scenarios. For example, if a test is performed at high, medium, and low frequencies, with hopping both on and off, there would be six extended screens. An example of the first extended screen for the single sensitivity test is shown below.

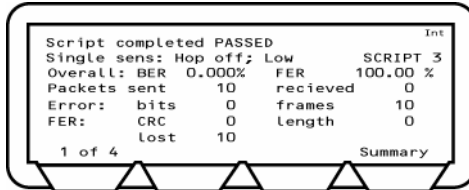

6. Page through the extended screens with the soft key in the normal manner, or press the [Summary] soft key to revert to the initial summary page.

Null packet mode

This test cannot be performed in null packet mode.

Multi Sensitivity Test Results

Standard and single packet modes

1. Select "Multi sensitivity" from the Script menu.
2. Press the **[Results]** soft key.

The Multi sensitivity results screens are displayed.

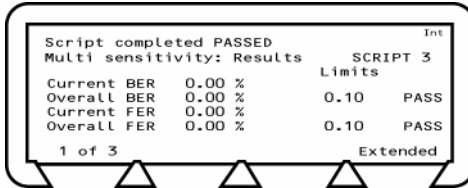

3. Press the **[1 of 3]** soft key to move to the second screen.

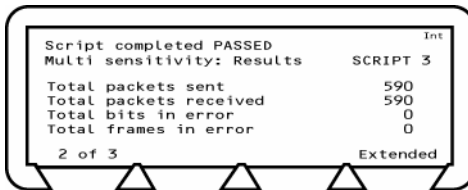

4. Press the **[2 of 3]** soft key to move to the third screen.

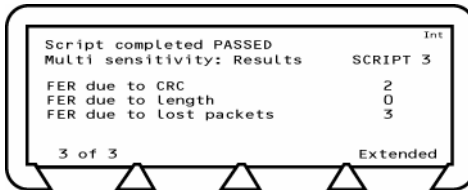

Definition of test results

- Current BER Displays the BER as measured in the last 10 returned packets.
- Overall BER Displays the BER for all the returned packets.
- Current FER Displays the FER as measured in the last 10 returned packets.
- Overall FER Displays the FER for all the returned packets.
- FER due to CRC Displays the number of packets returned that had a CRC error. These packets are used in BER calculations.
- FER due to length Displays the number of packets returned where the payload length of the packet was incorrect. This will also result in a CRC error. These packets are used in BER calculations.
- FER due to lost packets A lost packet will result from the MT8852B:
 - Not recognising the sync word header as being correct.

- The packet fails the Header Error Correction (HEC)
- No packet received at all during the expected time slot.
- NACK packet is received.

These packets are not used in BER calculations.

5. Press the **[Extended]** soft key to display more detailed test results. As opposed to the summary screen shown above, the extended screens are specific to each of the test scenarios. For example, if a test is performed at high, medium, and low frequencies, with hopping both on and off, there would be six extended screens. An example of the first extended screen for the multi sensitivity test is shown below.

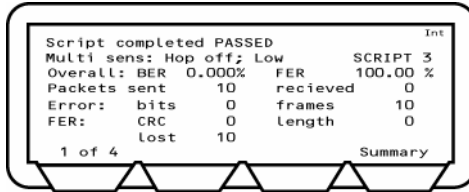

6. Page through the extended screens with the soft key in the normal manner, or press the **[Summary]** soft key to revert to the initial summary page.

Null packet mode

This test cannot be performed in null packet mode.

Modulation Index Test Results

1. Select “Modulation index” from the Script menu.
2. Press the **[Results]** soft key.

The Output power results screen is displayed.

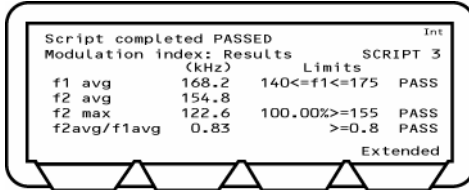

F1avg: MT8852B measures the maximum deviation for the second, third, sixth and seventh bit of each 11110000 payload byte. It then calculates the average value of all these deviations for each packet. This value is recorded as F1avg for each packet. The displayed value on the MT8852B is the highest F1avg value of all the packets that have been measured.

F2avg: MT8852B measures the maximum deviation of each 10101010 bit in the payload. The average of all these maximum deviations is then calculated and recorded as F2avg.

F2max: MT8852B measures the maximum deviation of each 10101010 bit in the payload. Each of these values is recorded as an F2max value. The displayed value of F2max is the single bit measured in a test that has the lowest recorded deviation. The percentage of F2max values that are greater than the limit of 115kHz is also displayed. The pass/fail criteria is made relative to the percentage value passed, and should exceed 99.9%.

Note: If any pattern errors are found in either the 11110000 or 10101010 payload, then these packets are discarded for measurement purposes.

3. Press the **[Extended]** soft key to display more detailed test results. As opposed to the summary screen shown above, the extended screens are specific to each of the test scenarios. For example, if a test is performed at high, medium, and low frequencies, with hopping both on and off, there would be six extended screens. An example of the first extended screen for the modulation index test is shown below.

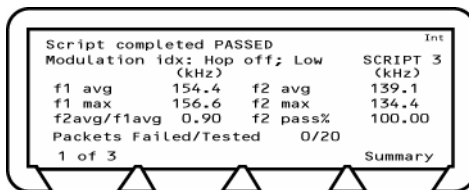

4. Page through the extended screens with the soft key in the normal manner, or press the **[Summary]** soft key to revert to the initial summary page. The Pass/Fail criterion for this test is defined in the Bluetooth specification to be the result of all deviations measured over all frequencies. It is therefore possible for the measured values for a single frequency to fail the limits, but the overall status to be a pass.

Maximum Input Power Test Results

Standard mode

1. Select "Max input power" from the Script menu.
2. Press the **[Results]** soft key.

The Maximum input power results screen is displayed.

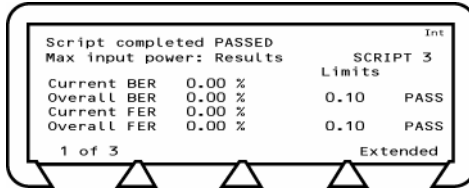

3. Press the **[1 of 3]** soft key to move to the second screen.

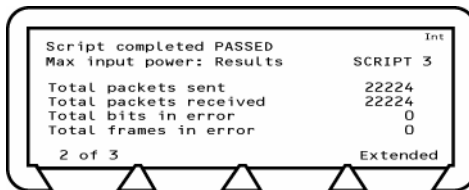

4. Press the **[2 of 3]** soft key to move to the third screen.

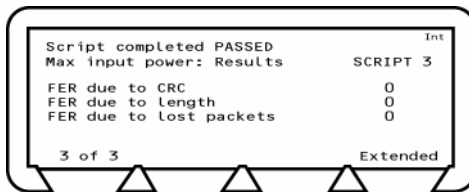

Definition of test results

- | | |
|-------------------|---|
| Current BER | Displays the BER as measured in the last 10 returned packets. |
| Overall BER | Displays the BER for all the returned packets. |
| Current FER | Displays the FER as measured in the last 10 returned packets. |
| Overall FER | Displays the FER for all the returned packets. |
| FER due to CRC | Displays the number of packets returned that had a CRC error. These packets are used in BER calculations. |
| FER due to length | Displays the number of packets returned where the payload length of the packet was incorrect. This will also result in a CRC error. These packets are used in BER calculations. |

FER due to lost packets

A lost packet will result from the MT8852B:

- Not recognising the sync word header as being correct.
- The packet fails the Header Error Correction (HEC)
- No packet received at all during the expected time slot.
- NACK packet is received.

These packets are not used in BER calculations.

5. Press the **[Extended]** soft key to display more detailed test results. As opposed to the summary screen shown above, the extended screens are specific to each of the test scenarios. For example, if a test is performed at high, medium, and low frequencies, with hopping both on and off, there would be six extended screens. An example of the first extended screen for the maximum input test is shown below.

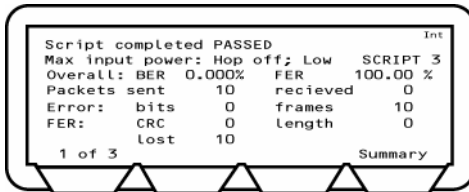

6. Page through the extended screens with the soft key in the normal manner, or press the **[Summary]** soft key to revert to the initial summary page.

Null packet mode

This test cannot be performed in null packet mode.

Single payload mode

This test cannot be performed in single payload mode.

Relative Tx Power Test Results

Standard mode

1. Select "Rel Tx power" from the EDR Script menu.
2. Press the **[Results]** soft key.

The Rel Tx power results screen is displayed.

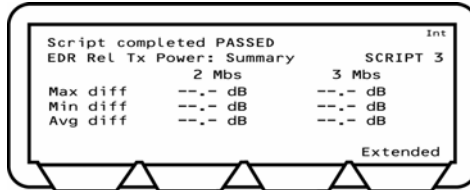

Definition of test results

- Max diff** Displays the maximum power difference between the GFSK and the PSK parts of a packet measured for all the packets tested.
- Min diff** Displays the minimum power difference between the GFSK and the PSK parts of a packet measured for all the packets tested.
- Avg diff** Displays the average power difference between the GFSK and the PSK parts of a packet averaged over all the packets tested.

3. Press the **[Extended]** soft key to display more detailed test results. As opposed to the summary screen shown above, the extended screens are specific to each of the test scenarios. For example, if a test is performed at high, medium, and low frequencies, with hopping off and testing at both EUT maximum power and EUT minimum power, there would be six extended screens. An example of the first extended screen, for results from a hopping off test, EUT transmitting at maximum power at the lowest frequency (default channel 0) is shown below.

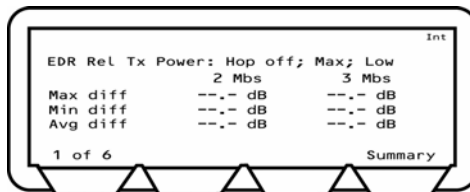

4. Page through the extended screens with the soft key in the normal manner, or press the **[Summary]** soft key to revert to the initial summary page.
5. Every packet tested must pass the specified criteria. The test specification defines this to be: Pass criteria = (PGFSK - 4dB) < PDPSK < (PGFSK + 1dB)

Null packet mode

This test cannot be performed in null packet mode.

Single payload mode

This test cannot be performed in single payload mode.

Carrier & Modulation Test Results

Standard mode

1. Select "Carrier & mod" from the EDR Script menu.
2. Press the **[Results]** soft key.

The Carrier & mod power results screen is displayed.

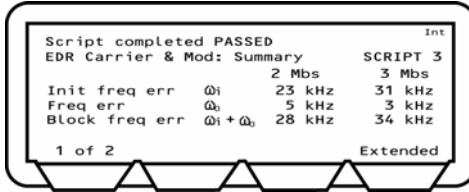

3. Press the **[1 of 2]** soft key to move to the second screen.

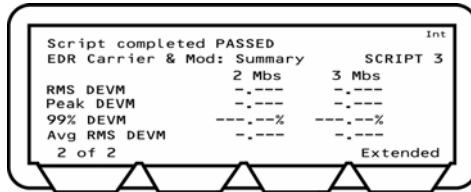

Definition of test results

- Init freq err** The initial frequency value (known as ω_i) is the frequency error of the EDR packet measured across the header part of the packet. The error value is displayed as the difference between the ideal frequency for the measured channel and the measured frequency over the header part of the packet. If more than one packet is required for the measurement, the value displayed is the greatest frequency error measured of all packets tested.
- Freq err** The Frequency Error value (known as ω_o) is the frequency difference between the Initial Frequency Error, and the average frequency of a 50 μ s block of payload data. The MT8852B divides the payload data into 50 μ s blocks and packets are looped back until 200 blocks have been measured. The value displayed is the greatest difference measured between any single 50 μ s payload block and the Initial Frequency error for the same packet.
- Block freq err** The block frequency Error ($\omega_i + \omega_o$) is the difference in frequency between any single 50 μ s payload block, and the header for the same packet. The MT8852B displays the greatest block frequency error for all the 200 blocks measured. As the block frequency error requires that each block is measured relative to the header from the same packet, it is possible that, when more than one packet is required to achieve the 200 measurement blocks, that the result for ($\omega_i + \omega_o$) is NOT equal to the sum of the displayed values of ω_i and ω_o .
- RMS DEVM** The MT8852B measures the RMS DEVM of 200 blocks of payload data, each block being 50 μ s long. The displayed value of RMS DEVM is the greatest value as calculated for each of the 200 blocks individually.

Peak DEVM	The peak DEVM value is the DEVM value of the single symbol in all the blocks measured that has the greatest value.
99% DEVM	The 99% DEVM is the percentage of symbols measured in all the blocks tested that are greater than the defined value (default conditions, 0.3 for $\pi/4$ DQPSK and 0.2 for 8DPSK).
Avg RMS DEVM	This displayed value is not specified in the <i>Bluetooth</i> test specification. It is defined as being the average value of all the RMS DEVM values measured in the "RMS DEVM" result. The purpose of this measurement is to indicate if the RMS DEVM value is typical of the performance of all the blocks measured, or if it represents a single large value.

- Press the **[Extended]** soft key to display more detailed test results. As opposed to the summary screen shown above, the extended screens are specific to each of the test scenarios. For example, if a test is performed at high, medium, and low frequencies, with hopping both on and off, there would be six extended screens. An example of the first extended screen is shown below.

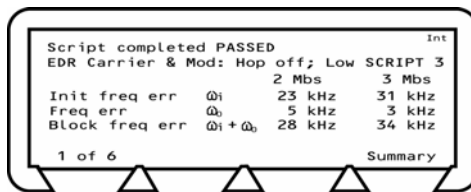

- Page through the extended screens with the soft key in the normal manner, or press the **[Summary]** soft key to revert to the initial summary page.

Null packet mode

This test cannot be performed in null packet mode.

Single payload mode

This test cannot be performed in single payload mode.

Differential Phase Test Results

Standard mode

1. Select "Diff phase" from the EDR Script menu.
2. Press the **[Results]** soft key.

The Diff phase results screen is displayed.

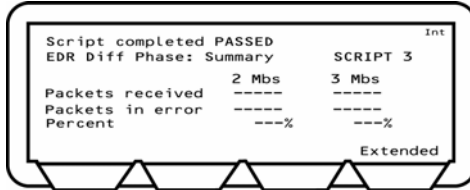

Definition of test results

- Packets received** The number of packets transmitted by the EUT and successfully received by the MT8852B
- Packets in error** The number of packets received that had errors in the PRBS9 payload as detected by the MT8852B.
- Percent** Ratio of packets received to packets in error.

3. Press the **[Extended]** soft key to display more detailed test results. As opposed to the summary screen shown above, the extended screens are specific to each of the test scenarios. For example, if a test is performed at high, medium, and low frequencies, with hopping both on and off, there would be six extended screens. An example of the first extended screen is shown below.

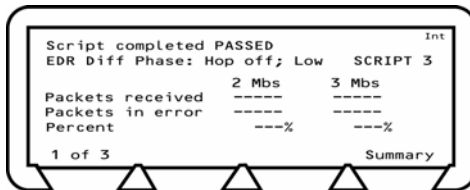

4. Page through the extended screens with the soft key in the normal manner, or press the **[Summary]** soft key to revert to the initial summary page.
5. Note:- In the Bluetooth specification, this test is only performed on 2-DH1 and 3-DH1 packets on channel 0.

Null packet mode

This test cannot be performed in null packet mode.

Single payload mode

This test cannot be performed in single payload mode.

EDR Sensitivity Test Results

Standard mode

1. Select "EDR Sensitivity" from the EDR Script menu.
2. Press the **[Results]** soft key.

The EDR Sensitivity results screen is displayed.

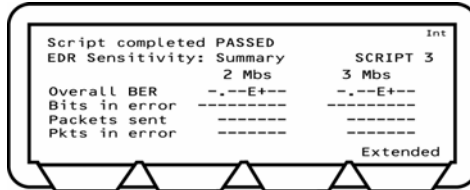

Definition of test results

- Overall BER** Number of payload bits received by the MT8852B in error as a percentage of the total number of payload bits received, expressed in exponent format. (0.1% displayed as 1 E -4) Note that according to the Bluetooth specification, packets not looped back by the EUT as a result of a sync check failure or header check failure are not included in the measurement.
- Bits in error** The actual number of bits transmitted in error by the EUT.
- Packets sent** The actual number of packets transmitted to the EUT by the MT8852B. Note this can be greater than the expected number if the EUT is dropping packets and the payload packet count is set to received. This is because the MT8852B will continue to transmit packets until the EUT has looped back the required number of bits even if some packets are lost by the EUT.
- Pkts in error** The number of packets incorrectly transmitted by the EUT. This includes, Nack'ed packets, Implicitly Nack'ed packets, packets with CRC errors, packets looped back with the incorrect length and lost packets.

3. Press the **[Extended]** soft key to display more detailed test results. As opposed to the summary screen shown above, the extended screens are specific to each of the test scenarios. For example, if a test is performed at high, medium, and low frequencies, with hopping both on and off, there would be six extended screens. An example of the first extended screen is shown below.

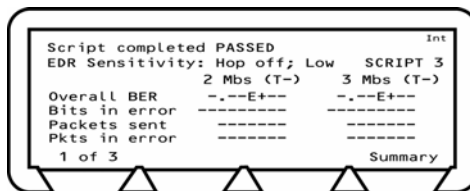

4. Page through the extended screens with the soft key in the normal manner, or press the **[Summary]** soft key to revert to the initial summary page.

Null packet mode

This test cannot be performed in null packet mode.

Single payload mode

This test cannot be performed in single payload mode.

EDR BER Floor Test Results

Standard mode

1. Select "EDR BER floor" from the EDR Script menu.
2. Press the **[Results]** soft key.

The EDR BER Floor results screen is displayed.

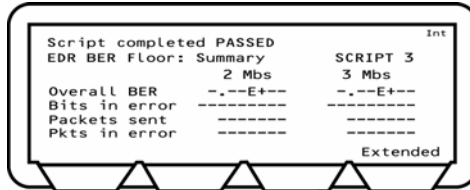

Definition of test results

As defined for EDR Sensitivity Test results

3. Press the **[Extended]** soft key to display more detailed test results. As opposed to the summary screen shown above, the extended screens are specific to each of the test scenarios. For example, if a test is performed at high, medium, and low frequencies, with hopping both on and off, there would be six extended screens. An example of the first extended screen is shown below.

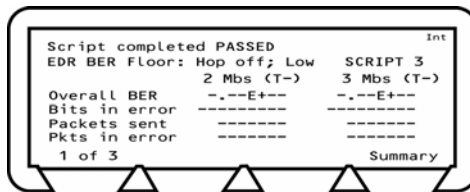

4. Page through the extended screens with the soft key in the normal manner, or press the **[Summary]** soft key to revert to the initial summary page.

Null packet mode

This test cannot be performed in null packet mode.

Single payload mode

This test cannot be performed in single payload mode.

EDR Maximum Input Level Test Results

Standard mode

1. Select "EDR Max input level" from the EDR Script menu.
2. Press the **[Results]** soft key.

The EDR Max input level results screen is displayed.

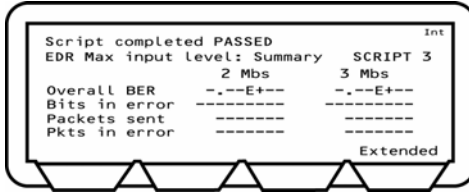

Definition of test results

As defined for EDR Sensitivity Test results

3. Press the **[Extended]** soft key to display more detailed test results. As opposed to the summary screen shown above, the extended screens are specific to each of the test scenarios. For example, if a test is performed at high, medium, and low frequencies, with hopping both on and off, there would be six extended screens. An example of the first extended screen is shown below.

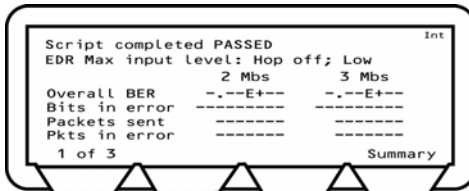

4. Page through the extended screens with the soft key in the normal manner, or press the **[Summary]** soft key to revert to the initial summary page.

Null packet mode

This test cannot be performed in null packet mode.

Single payload mode

This test cannot be performed in single payload mode.

Chapter 9. Audio Measurements

This chapter provides:

- An explanation of how the MT8852B can be used to perform audio measurements by establishing a SCO link between the MT8852B and the EUT.

The MT8852B Bluetooth Test Set can be used to perform audio measurements by establishing a Synchronous Connection Oriented (SCO) link between the MT8852B and the EUT. A SCO link is a full duplex link between a Bluetooth master and slave.

Note: It should be noted that SCO is an optional feature within the Bluetooth specification. The MT8852B can be used to establish a SCO link and transmit HV packets to, or from, the EUT. To perform audio measurements, an audio signal source and audio analyzer are also required (e.g., Keithley 2015).

There are four basic scenarios in which audio measurements may be made, each of which is illustrated and explained in this chapter. The four test scenarios are:

- Testing the EUT’s audio performance using remote loopback on the MT8852B.
- Testing the audio performance of the EUT transmit path.
- Testing the audio performance of the EUT receive path.
- Putting the EUT into remote loopback.

Testing the EUT’s Audio Performance Using Remote Loopback on the MT8852B

The EUTs audio performance can be tested using the set-up below. The MT8852B is put into remote loopback and the audio path tested without passing the signal through the MT8852B CODEC. The audio is looped back in the MT8852B baseband and so there is no audio distortion introduced by the tester.

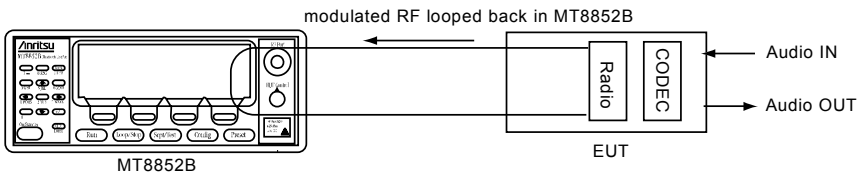

1. Press the **Config** button.
2. Select “MT8852B” and press the **Sel** key to display the MT8852B Configuration screen.
3. Select “Audio” and press the **Sel** key to display the screen below.

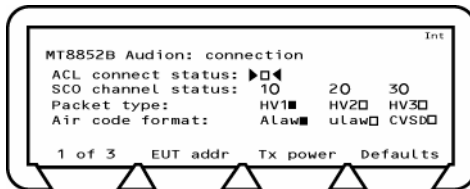

Note: The RF level used is the same level as that set for the script that was last run.

4. Press the **[EUT addr]** soft key and set the EUT address in the normal manner. Refer to “Entering the BT Address of the EUT” in chapter 8 of this manual for details.

5. Move the cursor to “ACL Connect status” and press the **[Sel]** key to establish an ACL connection. When the ACL connection has been established, the square indicator at the right of this item becomes solid and, if the EUT supports SCO, the indicators on the “SCO channel status” line change to clear squares to reflect this.
6. If the address source is set to RS232 or USB, it is now necessary to make the EUT settings shown in the screen below. Press the **[1 of 3]** soft key followed by the **[2 of 3]** soft key to display the third page.

Note: No settings are required on this screen if the EUT address source is not set to RS232 or USB. Skip to step 6 in this procedure if you are not initialising the EUT using the MT8852B “EUT Control” interface.

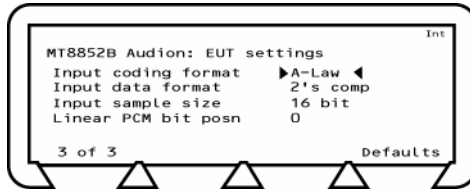

- | | |
|----------------------|---|
| Input coding format: | Select the EUT baseband sample input/output data format. There are three possible settings, “Linear”, “A-Law”, and “u-Law”. |
| Input data format: | Select the EUT baseband sample data format. There are three possible settings, “1’s”, “2’s”, and “sign magnitude”. |
| Input sample size: | Select either an 8 or 16 bit baseband sample size. |
| Linear PCM bit Posn: | Set the EUT Baseband sample offset within the 16 bit field. Specify a value within the range of 0 to 7. |

Note: When these settings are complete it will not be necessary to repeat this procedure until the EUT is changed.

7. Press **[3 of 3]** to return to page 1 and press the **[TX power]** soft key.
8. Enter the “TX power level” value using the keypad. The audio power level can be set to between 0 and -90 dBm.

Note: An ACL connection must be made before an SCO link can be established. When a device makes an ACL connection, it reports within its “Supported Features” response whether or not it supports SCO connections, and if so, which HV packet types it can support. **Do not** establish a SCO connection at this stage.

- Press the **[1 of 3]** soft key to display the second page.

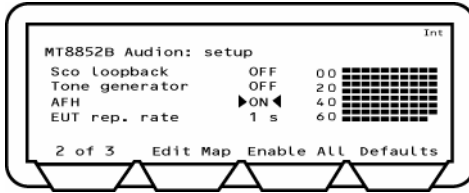

- Move the cursor to “SCO Loopback” and press the **(Sel)** key to turn remote loopback “ON”.
- Move the cursor to “Tone Generator” and press the **(Sel)** key to turn this ON or OFF as required. Setting the tone generator to ON results in the creation of a 1 KHz tone by the MT8852B that is transmitted over the SCO channel.
- The “AFH” and “EUT Rep. Rate” settings on this page are used are used for audio verification of EUT adaptive frequency hopping. Refer to chapter 10 in this manual, *Adaptive Frequency Hopping*, for a full explanation of this variant of AFH testing.
- Press the **[2 of 3]** soft key followed by the **[3 of 3]** soft key to return to the first page.

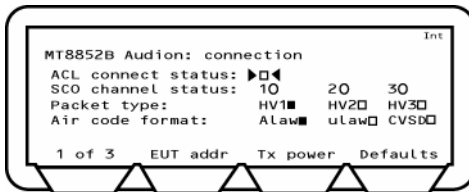

- Move the cursor to “Packet type” and select the HV packet type to be used. When the packet type is selected, the indicator to the right changes from clear to solid black.

Note: Some EUTs may not support all packet types. Only packet types reported as supported in “supported features” field are available and indicated on screen by a clear square.

HV1

Speech length / packet: 10 voice bytes (1.25 ms of speech)
 Payload length: 240 bits
 FEC: 1/3 FEC
 Transmission rate: Every TX time slot

HV2

Speech length / packet: 20 voice bytes (2.5 ms of speech)
 Payload length: 240 bits
 FEC: 2/3 FEC
 Transmission rate: Every second TX time slot

HV3

Speech length / packet:	30 voice bytes (3.75 ms of speech)
Payload length:	240 bits
FEC:	None
Transmission rate:	Every third TX time slot

8. Move the cursor to "Air code format", and select the required type. When the packet type is selected, the indicator to the right changes from clear to solid black. If the EUT is not being initialised via the MT8852B RS232 control interface, the MT8852B aircode must be set to match the setting of the EUT.
9. Finally, with all settings made, an SCO connection can now be established. Move the cursor to "SCO channel status" and select the channel or channels over which communications will be performed. Because the HV packet types use varying quantities of the total bandwidth, it may not be possible to select multiple channels with certain packet selections. Refer to the table below.

No. of channels	Packet type		
	HV1	HV2	HV3
1	✓	✓	✓
2	✗	✓	✓
3	✗	✗	✓

Testing the Audio Performance of the EUT Transmit Path

The performance of the EUT transmitter can be tested in isolation with the set-up shown below.

- Position the signal generator and analyzer as shown in the diagram below.
- Follow the procedure for "Testing the EUTs Audio Performance" but set the "SCO Loopback" setting to "OFF" (step 8 in the procedure).

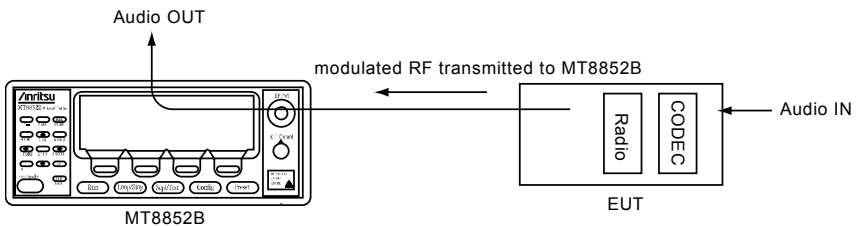

Refer to the figure below for details of jack plug wiring.

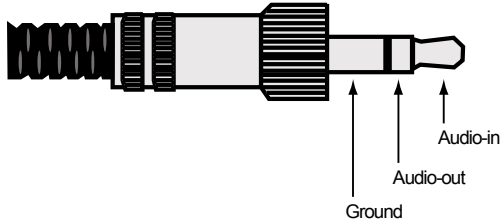

Testing the Audio Performance of the EUT Receive Path

The performance of the EUT receiver can be tested in isolation with the set-up shown below.

As a replacement for the external audio IN, it is also possible to use an internally generated tone. Use of this tone is ideal for quick tests and as it is generated internally, it does not pass through the MT8852B CODEC. The tone is fixed at 1kHz. For measurement at other frequencies use of external audio is required.

- Position the signal generator and analyzer as shown in the diagram below.

Note: Refer to the jack plug diagram on the previous page.

- Follow the procedure for “Testing the EUTs Audio Performance” but set the “SCO Loopback” setting to “OFF” (step 8 in the procedure).
- Set the “SCO tone generator” on page 2 of 3 to “ON” or “OFF” as required.

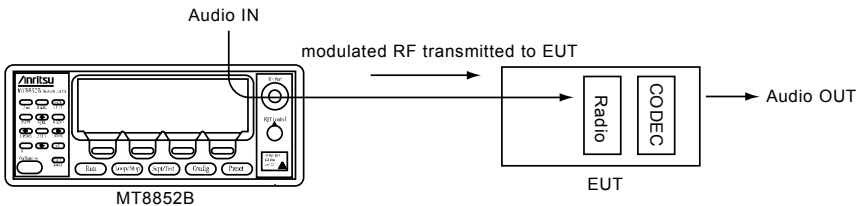

Putting the EUT into Remote Loopback

It is also possible to put the EUT into remote loopback. The MT8852B will then send and receive SCO packets from the EUT. The packets will be looped back digitally in the EUT baseband and so will not introduce any distortion from the analogue circuits.

As with the set-up for testing the performance of the receiver, it is also possible to use an internally generated 1 kHz tone. Use of this tone is ideal for quick tests and as it is generated internally, it does not pass through the MT8852B CODEC. The tone is fixed at 1kHz. For measurements at other frequencies use of external audio is required.

- Position the signal generator and analyzer as shown in the diagram below.

Note: Refer to the jack plug diagram on the previous page.

- Follow the procedure for “Testing the EUTs Audio Performance” and use the HCI software on the control PC to set the EUT to remoter loopback. SCO loopback for the MT8852B should be set to “OFF” (step 8 in the procedure).
- Set the “SCO tone generator” on page 2 of 3 to “ON” or “OFF” as required.

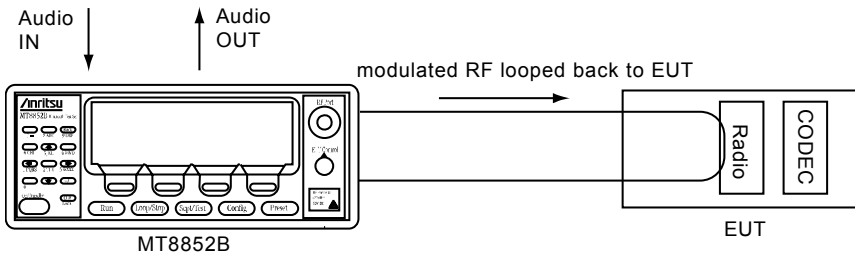

Using Audio Measurements with AFH

1. Press the **Config** button.
2. Select “MT8852B” and press the **Sel** key to display the MT8852B Configuration screen.
3. Select “Audio” and press the **Sel** key to display the page 1 of 1.
4. Press the [1 of 3] soft key to display page 2 of the audio section as shown below.

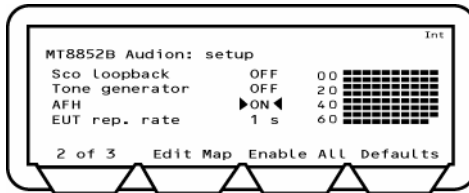

5. Set up an audio connection as detailed earlier in this chapter.
6. Introduce an interferer to add noise to the audio channel.
7. Verify the EUT's performance by turning on AFH (on the screen shown above) and listening to the decrease in noise as channels identified with interference are blocked.

Chapter 10. Adaptive Frequency Hopping (Option 15)

This chapter provides:

- An overview of the *Bluetooth* 1.2 specification and of AFH.
- Details of the AFH option for the MT8852B.
- An explanation of how to install the option and how to configure the MT8852B for AFH testing.

The *Bluetooth* 1.2 Specification

The 1.2 specification adopted by the Special Interest Group in November 2003 has two mandatory new features; faster connection and Adaptive Frequency Hopping (AFH). All other new features are optional.

- Faster connection

This is purely a change to the function of the EUT. Any developer that implements faster connection will see shorter connection times to a standard MT8852B.

- Adaptive Frequency Hopping (AFH)

AFH is a method used to improve the transmission quality within the highly frequented ISM band. It is used to prevent hopping to channels that are currently being used by an interfering 802.11b radio.

The 1.2 specification does not include higher data rate radios, and the RF test specification itself has remained unchanged from the 1.1 specification. AFH capabilities have been added as an option to the MT8852B to enable testing and verification of a device's performance in the presence of interfering signals. Further details of AFH and how it has been implemented are provided in this chapter.

Overview of Adaptive Frequency Hopping (AFH)

When two *Bluetooth* devices connect under normal circumstances, they establish a basic frequency hopping scheme across the 79 frequency channels in the 2.4 GHz ISM band, hopping at a rate of 1600 times per second. However, as is becoming increasingly common, interference may be encountered in environments where other wireless technologies, such as wireless LAN or DECT, are also in use in the same radio band. Blocked channels, caused by interference, result in a deterioration in the performance of the connection and this in turn is manifested in poor voice quality or reduced data transfer rates.

To limit the impact of this interference, an adaptation on frequency hopping, known as Adaptive Frequency Hopping (AFH) was introduced by the *Bluetooth* Special Interest Group in the 1.2 *Bluetooth* specification. AFH aims to restore the performance of a *Bluetooth* connection by identifying channels with high error rates and excluding the use of these channels thereafter.

The figure below shows an example of *Bluetooth* packets being blocked by WLAN transmission within the same radio band.

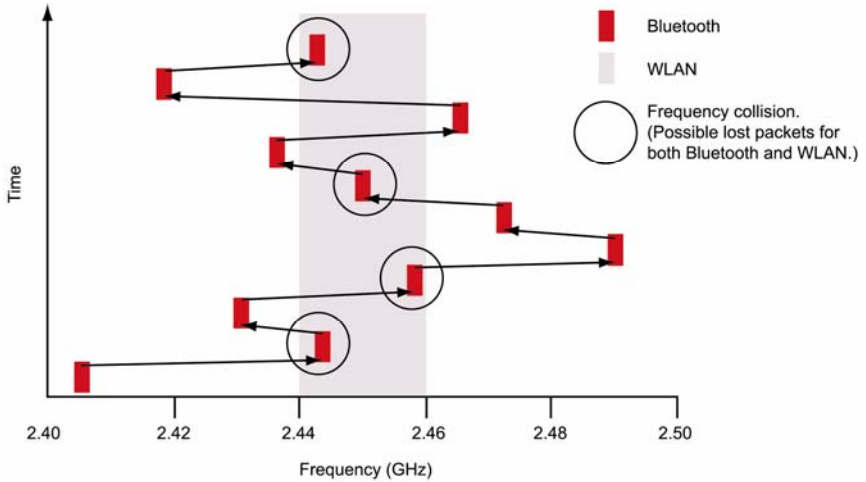

When AFH is enabled, the channels in use by WLAN are excluded and the *Bluetooth* packets are restricted to other channels where there is little probability of interference.

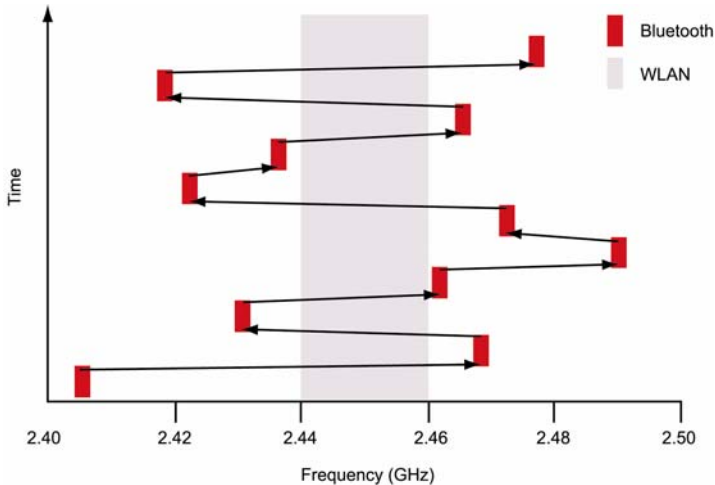

AFH Processing

As illustrated above, AFH allows *Bluetooth* devices to adapt to the environment by identifying sources of interference and then omitting them from the list of channels available for use.

To use AFH on a connection, both master and slave devices must support the feature, and the master selects whether or not to enable its use. When enabled, the master device generates a channel map to inform the slave device which of the 79 channels are available for use and which have been excluded.

The channel map is generated based on information from any or all of the following three sources.

- Channel classification sent over the HCI from the Host Controller. This would be applicable in the case of a PC supporting both *Bluetooth* and WLAN.
- The results of monitoring in the master device to build up a picture of which channels are experiencing interference problems. This information is referred to as the master's local assessment scheme (MLAS).
- The results of monitoring in the slave device to build up a picture of which channels are experiencing interference problems. This information is referred to as the slave's local assessment scheme (SLAS) and is relayed back to the master in channel classification reports.

Channel map generation is illustrated in the figure below.

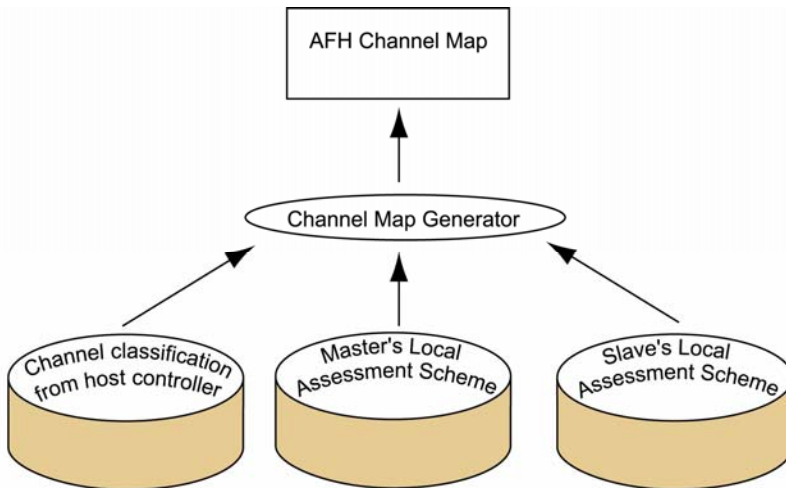

The channel map can be modified by the master device at any time during the life of a connection and is adopted immediately upon transmission to the slave.

In addition to the channel map, AFH also requires that *Bluetooth* devices communicate using the Same Channel Mechanism whereby, instead of changing frequency with each transmit and receive slot, the frequency is only changed after each complete transmit and receive cycle.

AFH in the *Bluetooth* 1.2 Specification

The *Bluetooth* Specification states that the master device creates the AFH Channel Map from any of the three sources identified above, but it does not dictate the method of channel assessment that should be used to identify the good and bad channels. Two common methods for making this judgement are Received Signal Strength Indication (RSSI), and Packet Error Rate (PER).

The following changes have been made to the 1.2 specification to enable the use of AFH.

- New messages have been added to the Link Manager Protocol to enable communication of the channels that can be used and the channels that have been blocked.
- Commands have been added to the Host Controller Interface to allow the blocking of “known bad” channels and to allow the host to obtain the channel map currently in use.

MT8852B Implementation of AFH

Adaptive frequency hopping is not enabled automatically when the MT8852B connects to a slave device that also supports AFH. The Host Controller must send explicit commands to enable or disable AFH operation.

The MT8852B has no algorithms for identifying the usability of channels, and as a result does not generate a “local assessment scheme”. Instead, commands at the user interface can be used to block channels in the creation of a “pseudo local assessment map”. The resultant active channel map is the logical OR of this pseudo local assessment map and the slave’s local assessment scheme (if the user enables use of this data). This is shown in the figure below.

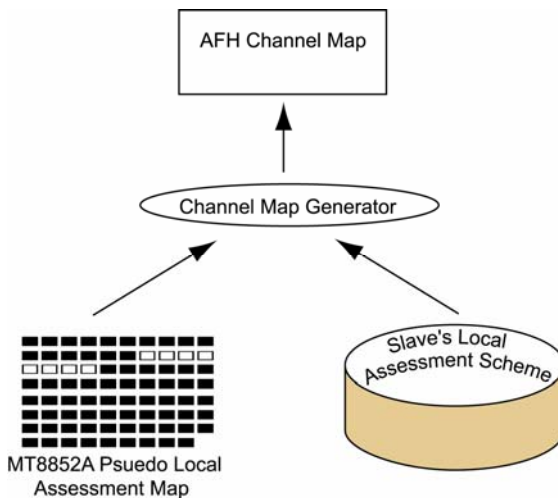

The Host Controller may change the AFH Channel Map at any time by sending an HCI command to the *Bluetooth* Controller. If there is an active connection that has AFH enabled, the new AFH Channel Map is adopted immediately. At other times the AFH Channel Map is stored in the *Bluetooth* Controller and used when AFH is next enabled.

The MT8852B gives the user three methods of verifying that AFH is functioning correctly:

- From Channel Use vs Time Information
- From FER vs Time Information
- From AFH from audio measurements

Note: The majority of EUTs are not able to update the AFH local assessment when being operated in test mode.

Installing the AFH Option

1. Ensure that the MT8852B software is version 4.00 or above.
2. Press the **Config** hard key.
3. Select “System features”.
4. Press the **Sel** key.
5. Select “Feature control”.
6. Press the **Sel** key.
7. Select “Option enable code” and press the **Sel** key.
8. Enter your option code number (15) from the numeric keypad and press the enter [Enter] soft key.
9. Enter your option password.
10. Press the [Enable] soft key to enable AFH.
11. Press the [1 of 2] soft key to display a list of all enabled options and check that the AFH option is listed.

Configuring the MT8852B for AFH Testing

1. Press the **Config** hard key.
2. Select “MT8852B”.
3. Press the **Sel** key.
4. Select “AFH Measurements”.
5. Press the **Sel** key to display the screen shown below.

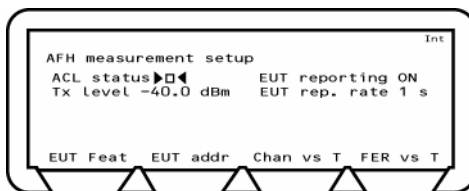

6. If the MT8852B is not already in an ACL connection with the EUT, a connection must now be established. Select the required EUT address source then select "ACL Status" and press the **[Sel]** key.
7. As mentioned in the previous section, the channel map is compiled from information from the MT8852B pseudo local assessment map and the EUT's local assessment scheme. Use of the latter is controlled by setting "EUT Reporting" to "On" or "Off". If set to "On", the EUT's local assessment scheme is used, and the rate at which the assessment is transmitted to the MT8852B is controlled by the setting at "EUT Rep. Rate". Enter a rate of between 1 and 30 seconds.
8. Select "TX Level" and enter the power level at which the MT8852B will transmit all packets whilst in AFH mode.

Note: The *Bluetooth* specification does not define how an EUT shall determine if a channel should be assessed as good or bad. Each chip set developer has implemented a unique channel assessment solution. The MT8852B displays the channel assessment map that a specific EUT has reported as a result of the continuous Poll/Null connection that exists between the MT8852B and the EUT.

Assessing AFH from Channel Use vs Time Information

Using this method the user can either edit the MT8852B's pseudo local assessment to simulate interference by blocking specific channels, or turn on an interference source and monitor the channels that are blocked automatically. The performance of the EUT can then be validated using the EUT's support software and the graph of channel use over time displayed by the MT8852B.

1. Configure the MT8852B as detailed earlier in this chapter.
2. Press the [Chan vs T] soft key to display the screen shown below.

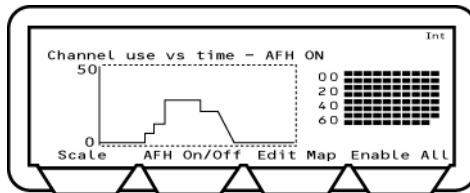

3. Press the [AFH On/Off] soft key to enable AFH. The current AFH status is shown in the display above the graph area.

Note: Connection Timer:

If option 15 (AFH) is enabled, the time taken to establish a connection displays on the top line of the screen shown above. An example of the display is shown below.

Connection made (1: 1054 ms)

The digit prior to the colon ("1" in the case of the example above) represents the number of attempts required to establish the connection. The figure following the colon represents the time in milliseconds taken to establish the connection.

4. Turn on the interfering source, or, if simulating interference, press the [Edit Map] soft key to display the screen shown below.

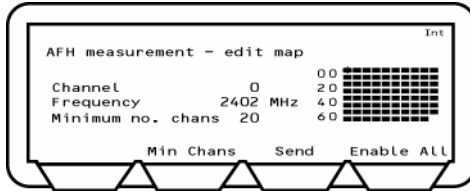

- Use the arrow keys on the keypad to position the crosshairs (shown in the figure above on the upper left channel) on the required channel(s), and press the **[Sel]** key to turn the channels on or off.
- When all the required channels have been 'blocked', press the **[Send]** soft key to update the active channel map.
- The results can be verified by using the EUT's support software and by returning to the previous screen and viewing the graph of channel use over time.

Assessing AFH from FER vs Time Information

Using this method the user activates an interference source into the EUT in order to validate that the EUT can recognize the channels that should be blocked. The performance of the EUT can be monitored at the MT8852B by confirming that the frame error rate shown on the graph drops as the channels in the channel plan to the right are blocked as required. FER is measured by counting the number of Null packets returned by the EUT as a result of the number of transmitted Poll packets. The FER measurement runs at a 1 second interval, and the FER measurement is always made on 800 transmitted packets.

- Configure the MT8852B as detailed earlier in this chapter.
- Apply interference to the EUT.
- Press the **[FER vs T]** soft key to display the screen shown below.

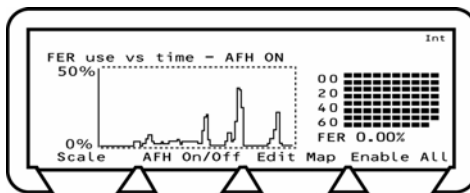

- Press the **[AFH On/Off]** soft key to enable AFH. The current AFH status is shown in the display above the graph area.
- Activate the interference source into the EUT.
- Confirm that the graph of FER over time drops down to zero as channels are systematically identified and blocked by the EUT.

Note: When displaying Channel use vs Time and FER vs Time, the MT8852B is sending Poll packets to the EUT in each transmit slots (800 polls a second).

Note: If an EUT continues to Inquiry scan and Page scan, following the establishment of a basic ACL connection, the MT8852B will measure a residual FER of around 2 to 4 % that exists, even on a good connection, due to management packets. It is advisable to disable Inquiry and Page scanning on the EUT while running FER vs time measurements.

Note: The decisions made in the EUT regarding which channels are good or bad, will vary significantly depending on the relative level of the interfering source and the MT8852B set power level. If the interfering source is connected directly to the EUT and the interfering power level exceeds -20dBm, this may saturate the EUT receiver and cause it to fail. The *Bluetooth* specification for receiver maximum input power is -20dBm.

Assessing AFH using Audio Measurements

1. Press the **Config** button.
2. Select "MT8852B" and press the **Sel** key to display the MT8852B Configuration screen.
3. Select "Audio" and press the **Sel** key to display the page 1 of 1.
4. Press the [1 of 3] soft key to display page 2 of the audio section as shown below.

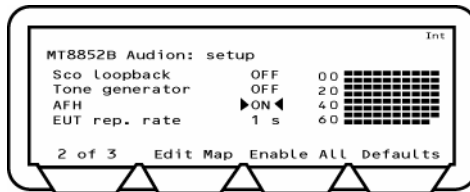

5. Set up an audio connection as detailed in chapter 9 of this manual.
6. Introduce an interferer to add noise to the audio channel.
8. Verify the EUT's performance by turning on AFH (on the screen shown above) and listening to the decrease in noise as channels identified with interference are blocked.

Chapter 11. IQ Data Output (Option 17)

This chapter provides:

- An explanation of how the IQ data output software option can be used to capture and view received EDR packets for more detailed analysis.
- How to run the software option, generate graphs, and save results.

The IQ data output software provides users with a means of capturing and viewing received packets without using protocol or making a connection. This option is useful for more detailed analysis of the transmitter performance of EDR chips and products. All three of the EDR transmitter measurements specified in the *Bluetooth* 2.0 specification can be performed.



The software :-

- Performs all measurements from a simple user interface with no signaling required.
- Performs all three EDR transmitter test cases (relative transmit power, carrier frequency stability, differential phase encoding).
- Allows the user to print and save the results of measurement.
- Supports 2-DH1, 2-DH3, 2-DH5, 3-DH1, 3-DH3, and 3-DH5 packets.

Note: It is not necessary to purchase option 17 in order to run EDR measurements on the standard MT8852B.

The [Anritsu *Bluetooth* EDR transmitter test software] window is divided into a number of panes. The measurement settings are made at the left side of the window and the results of measurement display to the right. The settings are described sequentially in this section.

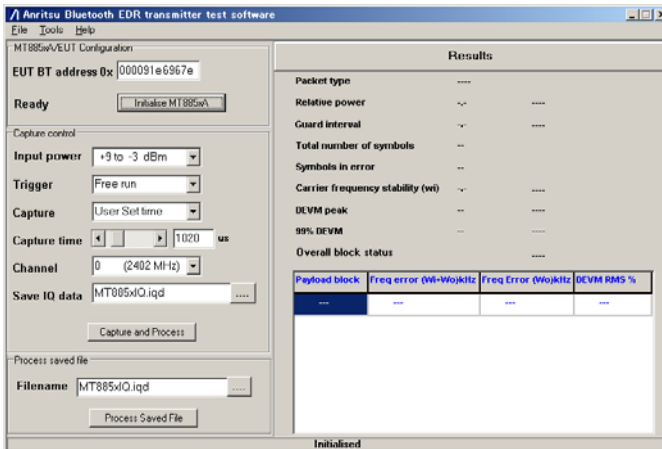

EDR Measurements

Relative Transmit Power (TP/TRM/CA/10C)

This test ensures that the difference in average transmit power during the frequency modulated [GFSK] and phase modulated [DPSK] parts of a packet is within the range specified below.

Pass criteria = $(P_{\text{GFSK}} - 4\text{dB}) < P_{\text{DPSK}} < (P_{\text{GFSK}} + 1\text{dB})$

Carrier Frequency Stability (TP/TRM/CA/11C)

This test verifies the transmitter carrier frequency stability and modulation accuracy. The measurement results must fulfill the following conditions.

Average frequency error of the GFSK portion of the EDR packet - ω_i (Pass criteria $\pm 75\text{kHz}$)

Average frequency error of each payload block - ω_0 (Pass criteria $\pm 10\text{kHz}$)

Modulation Accuracy

In this measurement, the payload is divided into blocks of 50 μs and the DEVM is measured for each symbol in the block. The pass criteria for this test are as follows.

RMS DEVM ≤ 0.20 for all $\pi/4$ -DQPSK blocks

RMS DEVM ≤ 0.13 for all 8DPSK blocks

Peak DEVM ≤ 0.35 for all $\pi/4$ -DQPSK symbols

Peak DEVM ≤ 0.25 for all 8DPSK symbols

99% DEVM ≤ 0.30 for 99% of $\pi/4$ -DQPSK symbols

99% DEVM ≤ 0.20 for 99% of 8DPSK symbols

Differential Phase Encoding (TP/TRM/CA/12C)

In this measurement the EUT transmits a packet with a defined PRBS9 payload. The payload of the received packet is demodulated and compared with the defined ideal packet to give a resultant symbol error rate. The *Bluetooth* 2.0 specification stipulates that zero errors are detected in 99% of 100 packets transmitted.

Guard Interval

The guard time is defined as the period starting at the end of the last GFSK symbol of the header and ending at the start of the reference symbol of the synchronization sequence. The length of the guard time must be between 4.75 μs and 5.25 μs .

Saving Results

The results of measurement can be saved to a text file or printed in the style shown below.

ANRITSU Bluetooth EDR transmitter test results

Date : 20 May 2005
 Time : 11:26

Bluetooth address : 0x000091e6967e
 Packet type : 2-DH1

TP/TRM/CA/10/C Relative transmitter power test

Relative power : -1.0 dB PASS
 Guard interval : 5.00 us PASS

TP/TRM/CA/12/C EDR Differential Phase Encoding test

Total number of symbols : 216
 symbols in errors : 0

TP/TRM/CA/11/C EDR Carrier Frequency Stability and Modulation Accuracy test

Carrier frequency stability (wi): -4.9 kHz PASS
 DEVM peak : 13 % PASS
 DEVM 99% : 12 % PASS
 Overall block status : PASS

Payload Block	Freq error (Wi+Wo)kHz	Freq error (Wo)kHz	DEVM RMS %
1	-4.9	-0.0	5
2	-6.0	-1.2	6
3	-4.3	0.6	6

Handling Results

Generating a Power Burst Profile Graph

A power burst profile can be generated from either the current set of measurement results or from previously saved IQ data.

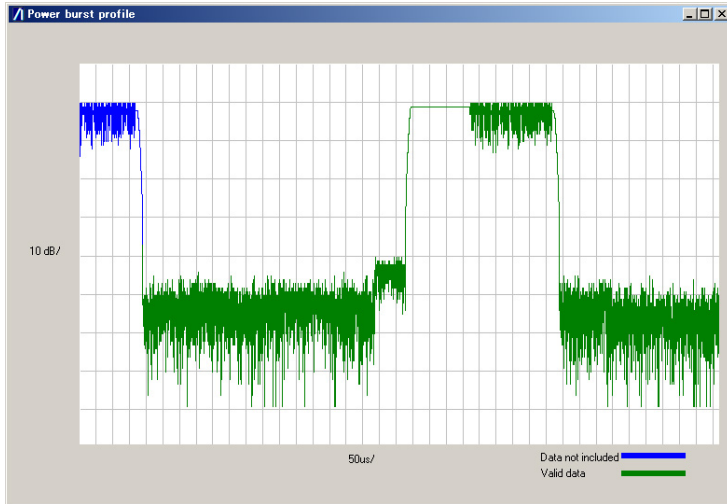

Generating Graphs from IQ Data

The automatically saved IQ data file can be opened in Microsoft Excel or similar spreadsheet package to generate power graphs and vector diagrams.

Appendix A. Top-line Messages

Introduction

The top line of LCD is reserved for conveying various types of information to the user. The 40 characters of this line are formatted as follows:

- The left most 30 characters are reserved for text messages of varying lengths with a maximum of 30 characters. All messages are left justified.
- The right most 9 characters are reserved for Icons/characters for specific instrument features
- The character is left blank between the message and the icons/characters to provide separation for clarity

Message Types

Each message type carries a particular kind of information. This consists of the following types of information:

Status	This indicates the internal state of the instrument such as: "Script running" "Script completed" This may be augmented by Measurement status message if relevant such as: "No payload detected " "Searching for channel" These two types of messages, when present, are displayed alternately.
Error	This can be an internal or operator error The cause of operator error, as the name implies, is an incorrect operation of the MT8852B, during setup/running of a test e.g. setup of out-of-range limit value for the pass/fail test criteria, results in the message " >Error!< out of range value"
Warning	This warns you of: Abnormal condition such as: "Warning: over temperature". Non-standard set up of an instrument such as: Null Packets. The icon "!" indicates this condition Conditions outside the control of MT8852B such as: "Warning: EUT via RF (0x%x)"
Information	This provides you with helpful information where relevant. For example, EUT (equipment under test) address mode: if the manual mode is selected following the auto, the unit disconnects from the EUT and the following message is displayed: "EUT disconnected"
Safety	The safety here refers to the MT8852B safety such as: " SYSTEM SHUTTING DOWN" " INTERNAL TEMPERATURE EXCEEDED"

Message Priorities

All status messages are mutually exclusive, for example:

“Making connection”

“Connection made”

Script running”

Depending on the use of instrument, more than one message type can be displayed.

For example, the messages “Null packets mode” and “Script running” may be displayed alternately:

On loss of connection, “Null packets mode” and “Connection lost” will be displayed:

Some message such as “>Error! < minimum value is -----” are displayed for a short period (2 seconds).

The safety message is exception to above set of rules. It has the highest priority, overriding any current messages. Example of safety message:

“SYSTEM SHUTTING DOWN INTERNAL TEMPERATURE EXCEEDED”

Error Codes

The vast majority of the top line error messages are self-explanatory and the required course of action will be immediately apparent. The table below lists the messages for which a note of explanation may be required.

Message	Meaning
AFH option not installed	Displays when the AFH enable is sent to a non AFH option enabled unit.
Authentication failure	The EUT has requested Authentication from the MT8852B in order to complete a connection. Set the "Authentication" item under Equipment Under Test to "Enabled".
Communication error	The EUT has not acknowledged a communication from the MT8852B and the MT8852B has run out of retries.
Connection ended by local host	The MT8852B ended the connection with the EUT.
Connection ended, low resource	The reason the EUT ended the connection was reported as due to low resources.
Connection lost, timed out	The MT8852B has not received any communication from the EUT for a defined period of time. The default time is 10 seconds. It can be set under Config \ MT8852B \ RXTX settings "Link timeout".
Connection made (n:time)	When option 15 is enabled, the connection number and time are in the following format. "Connection made (n:time)" n : Connection number time : Connection time in mS
Core busy, try again	When driving the MT8852B via GPIB using the auxiliary command, additional rules have to be applied as listed below. A. After a CONNECT command, check the connection complete bit (CON) of the INS register or the ERRLST output for the connection failure, before sending another command. B. After the INQUIRY command, check that the inquiry is complete using status bit (INQ) of the INS register before sending any other commands except INQCANCEL command.
CW Measurement mode	The MT8852B is configured as a signal generator. To return to normal <i>Bluetooth</i> test modes, press the "Exit" soft key.
DSP not communicating	Measurement processor is no longer communicating with the main processor.
Error!< External HCI	The MT8852B has been configured to be controlled by an external device through its rear panel RS232 HCI interface. To return to normal operating mode, press CONFIG\MT8852B\System interfaces – and set "RS232 mode" to EXT COMMS.
Error!< GPIB test config	When an instrument is in single test mode and configuration change or data read is attempted for another test, this message will appear.

Message	Meaning
Error!< in calibration mode	This message is output when trying to perform a test run whilst the instrument is in calibration mode.
Error!< locked script	It is not possible to edit a script that has been locked by another user. To lock and unlock scripts, press Scpt/Test, move the pointer to the script number and press the List soft key. The status of all scripts is then shown and can be changed using the soft keys.
Error!< non-editable script	Scripts 1 and 2 are factory set to represent common test requirements and cannot be altered by the user. To define your own script settings use scripts 3 to 10.
EUT not reached Max Power	The EUT was requested to go to maximum TX power and a MAX power LMP has not been received.
EUT not reached Min Power	The EUT was requested to go to minimum TX power and a MIN power LMP has not been received.
EUT RS232 not available	The MT8852B was requested to update the EUT settings via the EUT control RS232 interface when the <i>Bluetooth</i> address source was not set to RS232.
EUT test mode rejected	On completion of the ACL connection, the MT8852B sends an activate test mode command to the EUT. The EUT must have been preconfigured to accept this command. If the EUT has not been initialised to go into test mode, this error message is shown. Only Null packet mode testing can be performed in this condition.
EUT Unsupported feature	The MT8852B has sent a command to the EUT that the EUT cannot support.
External HCI interface	The instrument's <i>Bluetooth</i> core is now driven only by the RS232 connection on the MT8852B back panel using standard HCI commands.
Host timeout	The EUT has not responded to a connection request before the accept connection timer has expired.
Incorrect packet length	The packet received from the EUT is not the full length of a standard DH1, DH3 or DH5 packet. It is therefore not suitable for measurements.
Invalid Air code	When attempting to establish a SCO connection with the EUT, the MT8852B air code must correspond to the air code used by the EUT. Press Config \ MT8852B \ Audio and set the air code format to match that of the EUT, before attempting a SCO connection.
Invalid LMP parameters	The EUT rejected the LMP due to the parameters not being compatible with its present state.
Invalid packet type	Warning message from the measurement processor that the packet received was not the type it had been requested to measure.

Message	Meaning
Invalid Payload	The payload has been corrupted and cannot be used for measurements. Typically this would be an error in the 10101010 or 11110000 bit structure.
LMP timeout (TC: xx HOP: ON or OFF)	The MT8852B has sent an LMP test control to the EUT and the EUT has not responded with an LMP accepted message. "xx" represents the scenario number as defined in the <i>Bluetooth</i> test mode specification. The following numbers are used: 0: Pause Test Mode 3: Transmitter test – 1010 pattern 4: Transmitter test – PRBS9 5: Closed loop back – ACL packets 7: ACL packets without whitening 9: Transmitter test – 11110000 pattern
LMP timeout (test pause)	The EUT has not sent an LMP accepted message to the Test Pause message sent by the MT8852B.
Loop: current test failed	The MT8852B is running a test or script in loop mode with the "loop stop on fail" option ON. A measurement has failed causing the test or script to stop running.
Max number of connections	Maximum number of ACL connections.
Max number of SCO conns	It is not possible to set up more than 3 SCO connections.
No connection made, timeout	When attempting to establish a connection, the process failed due to a timeout.
No packet detected	Warning from the measurement processor. A request to measure has been received and no packets have been detected.
No payload detected	The packets looped back by the EUT appear to have no payload. The EUT may be looping back Null packets only.
No sync word correlation	The MT8852B is unable to correlate to the EUT transmitted packets header.
No test control End event	The end of the test sequence has not been received.
Non <i>Bluetooth</i> USB device	The USB device attached is not a <i>Bluetooth</i> device.
Not enough Measurements	The MT8852B did not receive sufficient measurable packets to complete the selected test.
Null packets mode	The MT8852B is configured to make simple measurements on Null packets transmitted by the EUT. To return to standard <i>Bluetooth</i> operating modes press Scpt/Test , move the pointer to the script number and press the setup softkey. Set "Script mode" to Standard.

Message	Meaning
Operation not allowed	When changing EUT audio settings, an ACL connection must be established first.
Repeated attempts	The EUT reports that too little time has elapsed since an unsuccessful attempted to connect, authenticate or pair.
Role change not allowed	During the connection process the EUT has attempted to become the piconet master. This is not allowed by the MT8852B which must always remain the piconet master. Reconfigure the EUT such that it does not attempt to become a master on connection.
Signal Over Range	The EUT power is greater than the input range of the MT8852B. The maximum input power for measurement is +23dBm.
Signal Under Range	The EUT power is below the input range of the MT8852B. The minimum input power to maintain a link is -55dBm, and for power measurements is -30dBm.
Single Payload mode	MT8852B has been configured to test an EUT by sending one test control at a time. This limits the speed with which a range of measurements can be made, but can improve reliability with EUTs that do not yet have a robust implementation of test mode signalling. To return to the standard <i>Bluetooth</i> operating mode press Scpt/Test, move the pointer to the script number and press the setup softkey. Set "Script mode" to Standard.
Synchronisation error	The EUT control RS232 control of the EUT has received an illegal sequence.
Test stopping	A test stop has been requested and the test is in the process of stopping.
Unknown HCI command	When under External HCI control, an unrecognised HCI command has been received.
Unsupported feature	The EUT has been requested to use a feature it does not support.
USB device attached	A USB device has been attached and is ready.
USB device removed	A USB device has been removed.
EDR 8PSK Modulation not found	The tester was expecting an 8-DPSK modulated EDR packet but the decoded packet type field does not indicate an 8-DPSK packet.
EDR Expected length mismatch	The tester was expecting a payload length of a given number of bytes, but the decoded payload field does not give the same result.
EDR Insufficient blocks	Insufficient data blocks detected in the EDR portion for packet analysis to occur.
EDR PI/4 Modulation not found	The tester was expecting a pi/4-DQPSK modulated EDR packet but the decoded packet type field does not indicate a pi/4-DQPSK packet.
EDR sync word exceeds limits	The EDR synchronisation word has been detected outside of its expected location.

Message	Meaning
Error locating EDR sync word	The EDR synchronisation word could not be located. The location of the EDR synchronisation word is incorrect or the EDR synchronisation word is incorrect/corrupted.
Error locating GFSK sync word	The GFSK synchronisation word could not be located. A common cause is the access code is set incorrectly or is corrupted, or the location of the GFSK synchronisation word is incorrect.
GFSK sync word exceeds limits	The GFSK synchronisation word has been detected outside of its expected location.

HCI and Communication List of Error Codes

This section lists the various possible error codes. The detail explanation of each error code is given in the *Bluetooth* specification Part H:1, Host Controller Interface , section 6.2 .

Bluetooth Specification 1.1 Devices

0x01	Unknown HCI Command.
0x02	No Connection.
0x03	Hardware Failure.
0x04	Page Timeout.
0x05	Authentication Failure.
0x06	Key Missing.
0x07	Memory Full.
0x08	Connection Timeout.
0x09	Max Number Of Connections.
0x0A	Max Number Of SCO Connections To A Device.
0x0B	ACL connection already exists.
0x0C	Command Disallowed.
0x0D	Host Rejected due to limited resources.
0x0E	Host Rejected due to security reasons.
0x0F	Host Rejected due to remote device is only a personal device.
0x10	Host Timeout.
0x11	Unsupported Feature or Parameter Value.
0x12	Invalid HCI Command Parameters.
0x13	Other End Terminated Connection: User Ended Connection.
0x14	Other End Terminated Connection: Low Resources.
0x15	Other End Terminated Connection: About to Power Off.
0x16	Connection Terminated by Local Host.
0x17	Repeated Attempts.
0x18	Pairing Not Allowed.
0x19	Unknown LMP PDU.
0x1A	Unsupported Remote Feature.
0x1B	SCO Offset Rejected.
0x1C	SCO Interval Rejected.
0x1D	SCO Air Mode Rejected.
0x1E	Invalid LMP Parameters.
0x1F	Unspecified Error.
0x20	Unsupported LMP Parameter Value.
0x21	Role Change Not Allowed
0x22	LMP Response Timeout
0x23	LMP Error Transaction Collision
0x24	LMP PDU Not Allowed
0x25	Encryption Mode Not Acceptable
0x26	Unit Key Used
0x27	QoS is Not Supported
0x28	Instant Passed
0x29	Pairing with Unit Key Not Supported
0x2A-0xFF	Reserved for Future Use.

Bluetooth Specification 2.0 Devices

0x00	Success
0x01	Unknown HCI Command
0x02	Unknown Connection Identifier
0x03	Hardware Failure
0x04	Page Timeout
0x05	Authentication Failure
0x06	PIN or Key Missing
0x07	Memory Capacity Exceeded
0x08	Connection Timeout
0x09	Connection Limit Exceeded
0x0A	Synchronous Connection Limit To A Device Exceeded
0x0B	ACL Connection Already Exists
0x0C	Command Disallowed
0x0D	Connection Rejected due to Limited Resources
0x0E	Connection Rejected Due To Security Reasons
0x0F	Connection Rejected due to Unacceptable BD_ADDR
0x10	Connection Accept Timeout Exceeded
0x11	Unsupported Feature or Parameter Value
0x12	Invalid HCI Command Parameters
0x13	Remote User Terminated Connection
0x14	Remote Device Terminated Connection due to Low Resources
0x15	Remote Device Terminated Connection due to Power Off
0x16	Connection Terminated By Local Host
0x17	Repeated Attempts
0x18	Pairing Not Allowed
0x19	Unknown LMP PDU
0x1A	Unsupported Remote Feature / Unsupported LMP Feature
0x1B	SCO Offset Rejected
0x1C	SCO Interval Rejected
0x1D	SCO Air Mode Rejected
0x1E	Invalid LMP Parameters
0x1F	Unspecified Error
0x20	Unsupported LMP Parameter Value
0x21	Role Change Not Allowed
0x22	LMP Response Timeout
0x23	LMP Error Transaction Collision
0x24	LMP PDU Not Allowed
0x25	Encryption Mode Not Acceptable
0x26	Link Key Can Not be Changed
0x27	Requested QoS Not Supported
0x28	Instant Passed
0x29	Pairing With Unit Key Not Supported
0x2A	Different Transaction Collision
0x2B	Reserved
0x2C	QoS Unacceptable Parameter
0x2D	QoS Rejected
0x2E	Channel Classification Not Supported
0x2F	Insufficient Security
0x30	Parameter Out Of Mandatory Range
0x31	Reserved
0x32	Role Switch Pending

0x33	Reserved
0x34	Reserved Slot Violation
0x35	Role Switch Failed

Internal HCI and Communication List of Error Codes

Error	Code Description
0x51	Message from state controller unknown
0x52	Command from state controller unknown
0x53	Failed to create piconet
0x54	Disconnect returned fail
0x55	Failed to communicate to HCI comm. Port
0x56	Timeout on reply from BBP HCI
0x57	HCI link returned fail
0x58	Missing event in protocol
0x59	Timed out waiting to receive the required measurements
0x5A	Did not receive a TX/LB end event
0x5B	The EUT has not been put into test mode
0x5C	Core returned a hardware error event
0x5D	HCI command not implemented
0x5E	SYNC or invalid packet length error
0x5F	DSP not communicating
0x60	Max power not reached
0x61	Min power not reached

"Error finding packet start"	There was no packet burst found.
"Error locating GFSK sync word"	Could not correlate with the correct Access Code.
"GFSK sync word exceeds limits"	Found the access code, but is in the wrong position.
"Error locating EDR sync word"	Could not find the EDR SYNC pattern in the packet.
"EDR sync word exceeds limits"	Found the EDR SYNC, but is in the wrong position.
"Error decoding the packet type"	Decoded packet type does not match the correct type.
"EDR mod. mode not specified"	Modulation mode not specified.
"EDR PI/4 Modulation not found"	Received packet type is incorrect.
"EDR 8PSK Modulation not found"	Received packet type is incorrect.
"EDR Unknown packet type"	Could not decode packet type.
"EDR Expected length mismatch"	Received packet type is wrong length.
"EDR Insufficient blocks"	Received packet type is wrong length.

Appendix B. Terminology Glossary

The table below provides an alphabetical glossary of some of the acronyms used in this, and associated documentation.

ACK	Acknowledge
ACL	Asynchronous Connectionless
AFH	Adaptive Frequency Hopping
BER	Bit Error Rate
BT	<i>Bluetooth</i>
CODEC	Coder-Decoder
CRC	Cyclic Redundancy Check
CVSD	Continuous Variable Slope Delta Modulation
CW	Continuous wave
DH	Data-High Rate
EDR	Enhanced Data Rate
eSCO	extended Synchronous Connection-oriented
ETSI	European Telecommunications Standards Institute
EUT	Equipment Under Test
FEC	Forward Error Correction
FER	Frame Error Rate
FPGA	Field Programmable Gate Array
GPIB	General Purpose Interface Bus
HCI	Host Controller Interface
HEC	Header-Error-Check
HV1,2,3	High Quality Voice
IEEE	Institute of Electronic and Electrical Engineering
ISM	Industrial, Scientific, Medical
LAN	Local Area Network
LM	Link Manager
LMP	Link Manager Protocol
MLAS	Master's Local Assessment Scheme
NACK	Negative Acknowledgement Message
POST	Post-On Self Test
PRBS	Pseudorandom Bit Sequence
RF	Radio Frequency
RGH	Range
RS232	Serial communications interface defined by EIA

RSSI	Received Signal Strength Indication
RX	Receiver
SCO	Synchronous Connection Oriented
SIG	Special Interest Group
SLAS	Slave's Local Assessment Scheme
STE	Symbol Timing Error
TCP/IP	Transport Control Protocol/Internet Protocol
TX	Transmit
USB	Universal Serial Bus
WLAN	Wireless Local Area Network

Appendix C. Preset Values

AFH	Off
Authentication	Disabled
Channel pattern	Standard (72 channels)
Display	Contrast = 5 Key click = ON Entry error beep = OFF
Display frequency as	MHz
End paging after	10 seconds
Errata 1158	ON
EUR reporting rate for AFH	1 second
EUT address source	Inquiry
EUT reporting for AFH	Off
EUT RS232 set up	Baud rate = 57600 Parity = None Data length = 8 bits Stop bits = 1 bit
GPIB address	Not changed
Inquiry scan	OFF
Inquiry set up	1 response 20 seconds Common name = ON
Link status	Will perform disconnect, if connected
Link timeout	10 seconds
Loop continuously	ON
Loop count	Continuous
Loop stop on test fail	OFF
Min Active channels for AFH	20
Modulation index	0.32
Path offset	Not changed
Payload pkt count	Transmitted
Range hold	Auto
Read EUT name on connection	OFF
RS232 baud rate	Not changed
RS232 mode	EXT COMMS
Script	QUICKTEST
Script mode	Standard
Script set up conditions	Not changed
Set EUT max pwr on connection	ON
Signal generator mode	OFF
Test pause	On

Test set up conditions	Not changed
TX power level	Not changed

Appendix D. Specification

This appendix provides the specification for the MT8852B *Bluetooth* Test Set.

Transmitter Tests

Test	Measurement Range	Hopping	Test Mode	Loopback (Or TX)	Payload	Packets	Measurement Control
Output Power	Average power + 22 dBm to -35 dBm Peak power + 23 dBm to -35 dBm	OFF and/or ON	ON	Loopback	PRBS 9	Longest Supported	To Qualification specification or user set; Low/Mid/High frequencies Number of returned packets
Power Control	Average power +22 dBm to -35 dBm Power steps measured	OFF	ON	Loopback	PRBS 9	DH 1	To Qualification specification or user set; Low/Mid/High frequencies Number of returned packets
Modulation Characteristics	0 kHz to 350 kHz	OFF	ON	TX mode or loopback	10101010 and 11110000	Longest Supported	To Qualification specification or user set; Low/Mid/High frequencies Number of returned packets
Initial Frequency	±1 kHz to ±150 kHz	OFF and/or ON	ON	TX mode or loopback	PRBS 9	DH 1	To Qualification specification or user set; Low/Mid/High frequencies Number of returned packets
Frequency Drift	DH 1/3/5 packets 0 kHz to 200 kHz >20000 Hz/50µs	OFF and/or ON	ON	TX mode or loopback	10101010	All supported packet lengths	To Qualification specification Hopping On/Off, or user set; Low/Mid/High frequencies Number of returned packets
Relative Tx power	+20 to -35dBm average power, +23dBm peak power.	OFF and/or ON	ON	TX mode or loopback		2DH1, 3, 5 and 3DH1, 3, 5	To Qualification specification Hopping On/Off, or user set; Low/Mid/High frequencies Number of returned packets
Carrier & modulation	0 Hz to ± 100 kHz	OFF and/or ON	ON	TX mode or loopback		2DH1, 3, 5 and 3DH1, 3, 5	To Qualification specification Hopping On/Off, or user set; Low/Mid/High frequencies Number of returned packets
Differential phase		OFF and/or ON	ON	TX mode		2DH1, 3, 5 and 3DH1, 3, 5	To Qualification specification Hopping On/Off, or user set; Low/Mid/High frequencies Number of returned packets

Receiver Tests

Test	Measurement Range	Hopping	Test-Mode	Loopback (Or TX)	Payload	Packets	Measurement Control
Sensitivity Single slot Dirty transmitter	BER 0.000% to 100% FER 0.000% to 100%	OFF and/or ON	ON	Loopback	PRBS 9	DH 1	To Qualification specification or user set; Low/Mid/High frequencies Number of returned packets
Sensitivity Single slot Clean transmitter	BER 0.000% to 100% FER 0.000% to 100%	OFF and/or ON	ON	Loopback	PRBS 9	DH 1	To Qualification specification or user set; Low/Mid/High frequencies Number of returned packets
Sensitivity Multi slot Dirty transmitter	BER 0.000% to 100% FER 0.000% to 100%	OFF and/or ON	ON	Loopback	PRBS 9	DH 5 (or DH3 if DH5 not supported)	To Qualification specification or user set; Low/Mid/High frequencies Number of returned packets
Sensitivity Multi slot Clean transmitter	BER 0.000% to 100% FER 0.000% to 100%	OFF and/or ON	ON	Loopback	PRBS 9	DH 5 (or DH3 if DH5 not supported)	To Qualification specification or user set; Low/Mid/High frequencies Number of returned packets
Max. Input	BER 0.000% to 100% FER 0.000% to 100%	OFF	ON	Loopback	PRBS 9	DH 1	To Qualification specification Hopping On/Off, or user set; Low/Mid/High frequencies Number of returned packets
EDR sensitivity	BER 0.000% to 100% FER 0.000% to 100%	OFF and/or ON	ON	Loopback		2DH1, 3, 5 3DH1, 3, 5	To Qualification specification Hopping On/Off, or user set; Low/Mid/High frequencies Number of returned packets
EDR BER floor	BER 0.000% to 100% FER 0.000% to 100%	OFF and/or ON	ON	Loopback		2DH1, 3, 5 3DH1, 3, 5	To Qualification specification Hopping On/Off, or user set; Low/Mid/High frequencies Number of returned packets
EDR max. input	BER 0.000% to 100% FER 0.000% to 100%	OFF and/or ON	ON	Loopback		2DH1, 3, 5 3DH1, 3, 5	To Qualification specification Hopping On/Off, or user set; Low/Mid/High frequencies Number of returned packets

Output Power

MT8852B measures average and peak power according to the *Bluetooth* RF Test Specification. Measurement of output power is made with the EUT in test mode, loopback enabled and hopping on. MT8852B transmits the longest supported packets and longest supported payload length, with a PRBS 9 payload. Power is measured at three defined frequencies. MT8852B identifies the position of p0 and measures the power of every bit in the packet.

Link conditions:

Hopping: OFF or ON – measure at Defined, All, or Any frequencies

Test mode: ON

Loopback or TX mode

Payload: PRBS 9

Packet type: DH1, DH3, DH5

Measurement:

Supported measurements: Average power, peak power

Number of measurement channels: User selectable, Defined (3), All, or Any

Measurement range: +22 dBm to -50 dBm average power (+23 dBm peak power)

Resolution: 0.1 dB

Accuracy: +20 dBm to -35 dBm, ± 1 dB

+22 dBm to +20 dBm, ± 1.5 dB

Power Control

MT8852B measures power control according to the *Bluetooth* RF Test Specification. Measurement of power control is made with the EUT in test mode, loopback enabled and hopping off. MT8852B transmits DH1 packets, with a PRBS 9 payload. Power control is measured at three defined frequencies. MT8852B uses standard LMP commands to set the EUT power. MT8852B identifies the position of p0 and measures the power of every bit in the packet.

Link conditions:

Hopping: OFF

Test mode: ON

Loopback or TX mode

Payload: PRBS 9

Packet type: DH1, DH3, DH5

Measurement:

Supported measurements: Maximum power, minimum power, maximum step size, minimum step size, and power at each power step.

Number of measurement frequencies: Three, default to qualification specification or user defined

Measurement range: +22 dBm to -35 dBm average power (+23 dBm peak power)

Resolution: 0.1 dB

Accuracy: +20 dBm to -35 dBm, ± 1 dB

+22 dBm to +20 dBm, ± 1.5 dB

Modulation Characteristics

MT8852B measures modulation characteristics according to the *Bluetooth* RF Test Specification.

Measurement of modulation characteristics is made with the EUT in test mode, loopback enabled and hopping off. MT8852B transmits longest supported packets, with the defined payload to the EUT.

Modulation characteristics are measured at three defined frequencies.

Link conditions:

Hopping: OFF

Test mode: ON

Loopback or TX mode

Payload: 11110000 and 10101010

Packet type: DH1, DH3, DH5

Measurement:

Supported measurements: Frequency deviation. $\Delta f1_{max}$, $\Delta f2_{max}$, $\Delta f1_{avg}$, $\Delta f2_{avg}$ and $\Delta f2_{avg}/\Delta f1_{avg}$ plus % of $\Delta f2_{max} < 115$ kHz

Number of measurement frequencies: Three, default to qualification specification or user defined

RF input measurement range: +20 dBm to -35 dBm

Deviation measurement range: 0 Hz to 350 kHz peak

Deviation resolution: 1 kHz

Accuracy: 1% for modulation index = 0.32

Initial Carrier Frequency Tolerance

MT8852B measures initial carrier frequency tolerance according to the *Bluetooth* RF Test specification.

Measurement of initial carrier frequency is made with the EUT in test mode, TX mode and hopping on and/or off. MT8852B transmits DH1 packets, with a PRBS 9 payload. Initial carrier frequency is measured at three defined frequencies. MT8852B identifies the position of p0 and measures the average frequency of the 4 preamble bits.

Link conditions:

Hopping: OFF or ON – measure at Defined, All, or Any frequencies

Test mode: ON

Loopback or TX mode

Payload: PRBS 9

Packet type: DH1

Measurement:

Supported measurements: Initial carrier frequency error

Number of measurement channels: User selectable, Defined (3), All, or Any

RF input measurement range: +20 dBm to -35 dBm

Initial frequency error measurement range: 0 Hz to ± 150 kHz

Frequency resolution: 1 kHz

Accuracy: 500 Hz \pm Frequency Standard

Carrier Frequency Drift

MT8852B measures carrier frequency drift according to the *Bluetooth* RF Test Specification. Measurement of frequency drift is made with the EUT in test mode, with either loopback or transmitter test mode enabled. EUT transmits longest supported packets, with a 10101010 payload to the EUT. Measurements are made with hopping off and then with hopping on. Frequency drift is measured at three defined frequencies with hopping off and every frequency with hopping on.

Link conditions:

Hopping: OFF or ON – measure at Defined, All, or Any frequencies

Test mode: ON

Loopback or TX mode

Payload: 10101010

Packet type: DH1, DH3, DH5

Measurement:

Supported measurements: Carrier frequency drift

Number of measurement channels: User selectable, Defined (3), All, or Any

RF input measurement range: +20 dBm to -35 dBm

Frequency drift measurement range: 0 Hz to 200 kHz, and > 2000/50µs

Frequency resolution: 1 kHz

Accuracy: 1 kHz

Relative Tx Power

MT8852B measures relative Tx power according to the *Bluetooth* RF Test Specification.

Link conditions:

Modulations:- $\pi/4$ DQPSK and 8DPSK

Packets:- 2-DH1,3,5 and 3-DH1,3,5.

Number of test packets:- default 10

Test control:- Loopback or Tx mode

EUT power level:- Max and Min

Hopping mode:- Off and On

Test channels:- Defined, All, Any (default defined, Low, Med High)

Measurement:

Supported measurements: Maximum differential power (from all packets), minimum differential power (from all packets), average differential power (over all packets).

Displayed results: Max differential power (from all packets), Min differential power (from all packets), Average differential power (over all packets)

Measurement range (Nominal): +20 to -35dBm average power, +23dBm peak power.

Relative power resolution: 0.01db, GFSK to $\pi/4$ DQPSK and 8DPSK

Relative power accuracy: Relative power measurement accuracy between GFSK and $\pi/4$ DQPSK or 8DPSK, 0.1dB for a power difference of < 6dB.

Relative power measurement range: Relative power measurement range between GFSK and $\pi/4$ DQPSK or 8DPSK, $(P_{\text{GFSK}} - 8\text{dB}) < P_{\text{DPSK}} < (P_{\text{GFSK}} + 4\text{dB})$.

Carrier Frequency Stability and Modulation Accuracy

MT8852B measures carrier frequency stability and modulation accuracy according to the *Bluetooth* RF Test Specification.

Link conditions:

Modulations;- $\pi/4$ DQPSK and 8DPSK

Packets;- 2-DH1,3,5 and 3-DH1,3,5.

Number of test blocks;- default 200

Test control;- Loopback or Tx mode

Hopping mode;- Off and On

Test channels;- Defined, All, Any (default defined, Low, Med High)

Measurement:

Displayed results: Initial frequency error ω_i , Frequency error ω_o , Frequency error $\omega_i + \omega_o$, RMS DEVM (block with greatest DEVM value displayed), Peak DEVM, 99% DEVM, Average RMS DEVM (average DEVM for all blocks measured)

Carrier freq stability Measurement range: 0 Hz to ± 100 kHz

Carrier freq stability accuracy: 500 Hz \pm Frequency Standard

Carrier freq stability resolution: ± 1 kHz

RMS DEVM range: 30% $\pi/4$ DQPSK, 20% 8DPSK

RMS DEVM resolution: 0.1% $\pi/4$ DQPSK and 8DPSK

Residual RMS DEVM: 2.5% (typical) $\pi/4$ DQPSK and 8DPSK

Peak DEVM range: 0 to 50% $\pi/4$ DQPSK, 0 to 30% 8DPSK

Peak DEVM resolution: 0.1% $\pi/4$ DQPSK and 8DPSK

Differential Phase Encoding

MT8852B measures differential phase encoding according to the *Bluetooth* RF Test Specification.

Link conditions:

Modulations: $\pi/4$ DQPSK and 8DPSK

Packets: 2-DH1,3,5 and 3-DH1,3,5.

Number of test packets: default 100

Test control: Tx mode

Hopping mode: Off and On

Test channels: Defined

Measurement:

Supported measurements: Differential Phase Encoding: Number of packets received, Number of packets with payload data errors, Percentage of errored packets

Number of measurement frequencies: Three, default to qualification specification or user defined

Sensitivity - Single Slot Packets

MT8852B measures single slot sensitivity according to the *Bluetooth* RF Test Specification

BER and FER are measured with the EUT in test mode and loopback on. MT8852B transmits DH1 packets, with a PRBS 9 payload to the EUT. The user can select to run the measurement with hopping on or off. Dirty transmitter conditions as defined in the *Bluetooth* test specifications can be enabled.

Link conditions:

Hopping: OFF or ON, user selectable

Test mode: ON

Loopback: ON

Payload: PRBS9

Packet type: DH1

Dirty transmitter (as defined in the RF test spec): ON or OFF, user selectable

Measurement:

Supported measurements: BER, total number of bit errors and FER

Number of measurement frequencies: Three with hopping off, or hopping on.

Number of measured bits: 1 to 32,768 packets (216 to 7,077,888 bits)

MT8852B transmitter output range: 0 dBm to -80 dBm, resolution 0.1 dB

BER/FER measurement range: 0.000% to 100%

BER/FER resolution: 0.001%

Dirty transmitter specification

MT8852B transmits the first 20 ms with the first set of measurement conditions, the second 20 ms with the second set of measurement conditions up to the tenth set of conditions. The cycle is then repeated until the test is complete.

Measurement conditions	Carrier frequency offset	Modulation index	Symbol timing error
1	75 kHz	0.28	-20 ppm
2	14 kHz	0.30	-20 ppm
3	-2 kHz	0.29	+20 ppm
4	1 kHz	0.32	+20 ppm
5	39 kHz	0.33	20 ppm
6	0 kHz	0.34	-20 ppm
7	-42 kHz	0.29	-20 ppm
8	74 kHz	0.31	-20 ppm
9	-19 kHz	0.28	-20 ppm
10	-75 kHz	0.35	+20 ppm

In addition to the above measurement conditions, MT8852B transmits with a sine wave, frequency modulation, with a deviation of ± 25 kHz. rate 1.6 kHz, synchronized to zero phase at the packet start.

Dirty transmitter, user control; any entry in the dirty transmitter table can be edited within the following ranges;

- Carrier frequency offset: 0 Hz to 100 kHz, 1 kHz resolution.
- Modulation index: 0.25 to 0.38, 0.01 resolution
- Symbol timing error: 0 ppm, +20 ppm or 20 ppm

Sensitivity - Multi-Slot Packets

MT8852B measures multi-slot sensitivity according to the *Bluetooth* RF Test Specification

BER and FER are measured with the EUT in test mode and loopback on. MT8852B transmits DH5 packets (or DH3 packets if DH5 not supported by EUT), with a PRBS 9 payload to the EUT. The user can select to run the measurement with hopping on or off. Dirty transmitter conditions as defined in the *Bluetooth* test specifications can be enabled.

Link conditions:

Hopping: OFF or ON, user selectable

Test mode: ON

Loopback: ON

Payload: PRBS 9

Packet type: DH3, DH5

Dirty transmitter (as defined in RF test spec): ON or OFF, user selectable

Measurement:

Supported measurements: BER, total number of bit errors and FER Number of measurement frequencies: Three with hopping off, or hopping on.

Number of measured bits: 1 to 32,768 packets (for DH3, 1,464 to 47,972,352 bits), (for DH5, 2,712 to 88,866,816 bits).

MT8852B transmitter output range: 0 dBm to -80 dBm, 0.1 dB resolution

BER/FER measurement range: 0.000% to 100%

BER/FER resolution: 0.001%

Dirty transmitter specification: as for single-slot sensitivity section except; in addition to the measurement condition table, MT8852B transmits with a sine wave, frequency modulation, with a deviation of ± 40 kHz, rate 500 Hz (3 slots) or 300 Hz (5 slots), synchronized to zero phase at the packet start.

Maximum Input Level

MT8852B measures BER and FER at the EUT maximum input level according to the *Bluetooth* RF Test Specification. Measurement is made with the EUT in test mode, loopback enabled and hopping off. MT8852B transmits the DH1 packets with a PRBS 9 payload. The MT8852B transmitter level is set so that the EUT receiver input level is -20 dBm. BER and FER are measured at three defined frequencies.

Link conditions

Hopping: OFF

Test mode: ON

Loopback: ON

Payload: PRBS 9

Packet type: DH1

Measurement:

Supported measurements: BER and FER for -20 dBm at receiver input

Number of measurement frequencies: Three, default to qualification specification or user defined

Number of measured bits: 1 to 32,768 packets (216 - 7,077,888 bits)

Transmitter power settable range: 0 dBm to -80 dBm

Resolution: 0.1 dB

EDR Sensitivity

MT8852B measures EDR sensitivity according to the *Bluetooth* RF Test Specification.

Link conditions:

Modulations: $\pi/4$ DQPSK and 8DPSK

Packets: 2-DH1,3,5 and 3-DH1,3,5.

Dirty transmitter control: On and Off

Payload bit count: transmitted or received

Bit threshold control;-default threshold 1, 1.6 million, threshold 2, 16 million (user editable)

Test control: Loopback

Hopping mode: Off and On

Test channels: Defined

Measurement:

Supported measurements: Overall BER (displayed in exponential format), number of bits in error, number of packets sent by test set, number of packets received in error by EUT.

Number of measurement frequencies: Three, default to qualification specification or user defined

MT8852B output range: 0 dBm to -90dBm

Resolution: 0.1 dB

Accuracy: ± 1 dB, 0 dBm to -80dBm

Dirty transmitter:

Frequency modulation error sine wave, ± 10 kHz deviation and 100 μ s period, plus table impairments below, cycled at a 20 packet rate.

Frequency conditions	Carrier Freq. Off	Sym. Timing Error
1	0 kHz	0 ppm
2	+ 65 kHz	+20 ppm
3	- 65 kHz	- 20 ppm

EDR BER Floor

MT8852B measures EDR BER floor performance according to the *Bluetooth* RF Test Specification.

Link conditions:

Modulations: $\pi/4$ DQPSK and 8DPSK

Packets: 2-DH1,3,5 and 3-DH1,3,5.

Payload bit count: transmitted or received

Bit threshold control: default threshold 1, 8 million, threshold 2, 160 million (user editable)

Test control: Loopback

Hopping mode: Off and On

Test channels: Defined

Measurement:

Supported measurements: Overall BER (displayed in exponential format), number of bits in error, number of packets sent by test set, number of packets received in error by EUT.

Number of measurement frequencies: Three, default to qualification specification or user defined

Measurement range: 0 to -90dBm

Resolution: 0.1 dB

Accuracy: ± 1 dB, 0 dBm to -80dBm

EDR Maximum Input

MT8852B measures EDR maximum input according to the *Bluetooth* RF Test Specification.

Link conditions:

Modulations: $\pi/4$ DQPSK and 8DPSK

Packets: 2-DH1,3,5 and 3-DH1,3,5.

Payload bit count: transmitted or received

Number of bits: default 1.6 million (user editable)

Test control: Loopback

Hopping mode: Off and On

Test channels: Defined

Measurement:

Supported measurements: Overall BER (displayed in exponential format), number of bits in error, number of packets sent by test set, number of packets received in error by EUT.

Number of measurement frequencies: Three, default to qualification specification or user defined

Measurement range: 0 to -90 dBm

Resolution: 0.1 dB

Accuracy: ± 1 dB, 0 dBm to -80 dBm

MT8852B Signal Generator

Frequency

Frequency range:	2.40 to 2.5 GHz
Frequency resolution	1 kHz
Frequency accuracy	As frequency standard \pm 500 Hz

Level

Amplitude range	0 dBm to -90 dBm
Amplitude accuracy	\pm 1 dB (0 dBm to -80 dBm)
Amplitude resolution	\pm 0.1 dB
Output impedance	50 Ohm (nominal)
Output VSWR	1.5:1 (typically 1.3)
	Adjacent channels 3 or higher -40 dBc
Spurious	30 MHz to 1 GHz; -36 dBc
	1 GHz to 12 GHz; -30 dBc
	1.8 GHz to 1.9 GHz; -47 dBc
	5.15 GHz to, 5.3 GHz; -47 dBc
	or -80 dBm, whichever is greater

Modulation

Modulation	GFSK
Modulation index	Variable, 0.25 to 0.38 (125 kHz to 190 kHz)
Mod index resolution	0.01
Mod index accuracy	1 % for Modulation Index = 0.32
Baseband filter	BT=0.5
Modulation	$\pi/4$ DQPSK
Mod index accuracy	< 5% RMS DEVM
Baseband filter	BT=0.4
Modulation	8DPSK
Mod index accuracy	< 5% RMS DEVM
Baseband filter	BT=0.4

MT8852B Measuring Receiver

Frequency

Range	2.40 to 2.5 GHz
Resolution	1 kHz
Accuracy	As frequency standard ± 500 Hz
Measurement channel bandwidth	2 MHz 3dB bandwidth, flat response $F_c \pm 550$ kHz, and 1.3 MHz 3dB bandwidth, flat response $F_c \pm 550$ kHz.

Level

Range	+22 dBm to -55 dBm average power
Power measurement accuracy	± 1 dB (+20 dBm to -35 dBm)
Input VSWR	1.5:1
Damage level	+25 dBm
Resolution	0.1 dB

Modulation

Modulation	GFSK
Deviation measurement range	0 to 350 kHz peak
Accuracy	1 % for Modulation Index = 0.32
Modulation	$\pi/4$ DQPSK, 8DPSK
Accuracy	<2.5% RMS DEVM typical

EUT Control Interface

The EUT control interface provides RS232 HCI commands to EUT through a standard RS232 interface. The interface meets the requirements of *Bluetooth* V1.1 specification for HCI UART transport layer. An RS232 cable is supplied.

The EUT control interface provides USB HCI commands to EUT through a standard USB interface. The interface meets the requirements of *Bluetooth* V1.1 specification section H:2. A USB cable is supplied.

Audio Specifications

Number of SCO channels supported	3
Codec air interfaces supported	CVSD, A-Law, μ -Law
Frequency response:	(-3dB) measured CODEC in to CODEC out: 160Hz -3.5kHz. Measured with 50 Ω source impedance and 10M Ω load impedance.
Maximum input / output signal level:	3.4V _{pk-pk} = 1.2V RMS.
Distortion/noise:	A law: typical -37dB @1kHz, 1V RMS μ law: typical -37dB @1kHz, 1V RMS CVSD: typical -30dB @300Hz, 1V RMS
Input/Output connectors	3.5mm audio jack plugs (one for each SCO channel)
Input impedance:	20K Ω .
Minimum output load:	600 Ω .
Internal audio source	1kHz fixed frequency

AFH (Option 15)

Supported in ACL and SCO connections.

Displays:	Active channel vs time, FER vs time.
Other features:	ACL connection timer, resolution 1 ms.

Frequency Standard

Frequency	10 MHz
Temperature Stability	± 0.5 ppm, -10°C to +85°C
Aging (1st year)	± 1.0 ppm
Aging (over 10 years)	± 2.5 ppm, including year 1

Rear Panel Connectors

External frequency standard input	Rear panel BNC socket, 50 Ω 1 volt
Output 1	TTL output for TX ON, TX DATA, RX DATA, and correlator.
Output 2	TTL output for RX ON, TX DATA, RX DATA, and correlator.
Input 1	For service use only

GPIB

IEE 488.2. Offers full instrument control as standard. User can also read the 4 x over-sampled magnitude and frequency values of each data bit in the last measured packet.

RS 232

RS 232 interface offering full instrument control as standard

Power Requirements

Supply	85 to 264 Volts AC
	47 to 63 Hz
	150 VA MAX

Environmental

Operating temperature	5 to +40°C
Operating humidity	20% to 75%
Safety	Complies with IEC 61010-1
EMC	Conforms to the protection requirements of EEC Council Directive 89/336/EEC.

Size and Weight

Dimensions	216.5 mm x 88 mm x 380 mm
Weight	<3.45 kg

Ordering Information

Included Accessories

Item	Quantity
MT8852B Operation Manual	1
MT8852B Remote Programming Manual	1
BlueSuite software (standard version)	1
RS232 HCI control interface lead	1
RS232 cable for firmware updates	1
Power cord for destination country	1
Certificate of calibration	1
USB HCI control interface lead	1
3.5 mm jack plug	3
BlueTest2 software	1

Options

Item	Part number
Rack Mount, single instrument	MT8850A-01
Rack Mount, side-by-side	MT8850A-03
<i>Bluetooth</i> antenna and adapter	MT8850A-10
Headset and Handsfree profile emulator software	MT8852A-14P/U
Adaptive Frequency Hopping	MT8852A-15
Encryption support	MT8852A-16
IQ data output	MT8850A-17
Spare EUT/RS232 cable	MT8850A-20
Spare EUT/USB cable	MT8850A-21
Extra Operation and Programming Manual	MT8850A-30
Soft carry case with shoulder strap	D41310
BlueSuite Pro software	
Z540, SO25 calibration certificate + test data	MT885xA-98
PREMIUM Z540, ISO25 calibration certificate + test data	MT885xA-99

Appendix E. Bit and Frame Error Rates

The flow diagram below illustrates the decision processing performed by the MT8852B in determining bit and frame error rates.

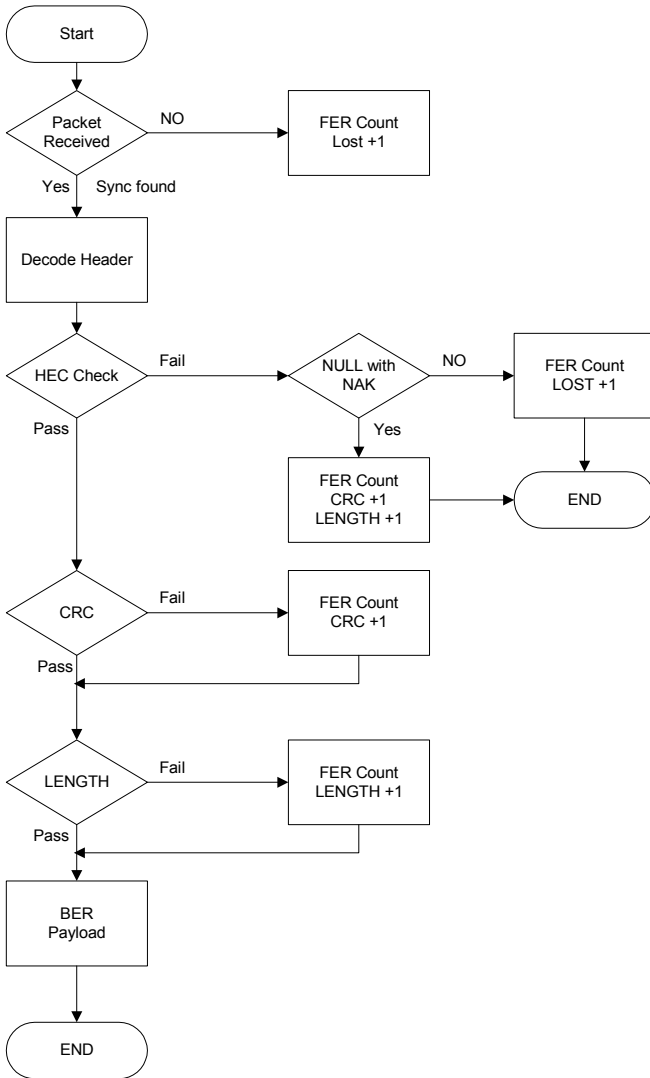

Appendix F. Technical Support

Whilst every effort has been made to ensure the quality and reliability of this product, there may be times when operation difficulties are experienced and technical support is required.

Technical support can be obtained in either of the following methods.

- Copy and fill out the form on the following page and fax it to Anritsu at the number shown.
- Send an e-mail to our technical support team at bluetooth.support@eu.anritsu.com providing the information indicated on the form.

The firmware version, serial number, and other unit specific information can be verified by following the procedure below.

1. Pressing the **Config** hard key.
2. Selecting "MT8852B" > "Identity"

Every effort will be made to ensure that you are contacted within one working day.

For the attention of “Bluetooth Technical Support”.

Please fill in this form in as much detail as possible and then FAX it to this number: +44 (0)1438 740202	
Product model:	MT8852B
Serial number:	
Firmware version:	
Core FPGA version	
DSP version	
Description of the problem:	
List of error messages:	
Description of steps required to reproduce the problem:	
Efforts already made to correct the problem:	

Appendix G. Connector Care and Handling

Follow the precautions listed below when handling or connecting cables. Complying with these precautions will guarantee longer component life and less equipment down time due to connector or device failure. Also, such compliance will ensure that

Beware of destructive pin depth mating connectors

Destructive pin depth of mating connectors is the major cause of failure in the field. When an RF component is mated with a connector having a destructive pin depth, damage will usually occur to the RF component connector. A destructive pin depth is one that is too long in respect to the reference plane of the connector (see figure below).

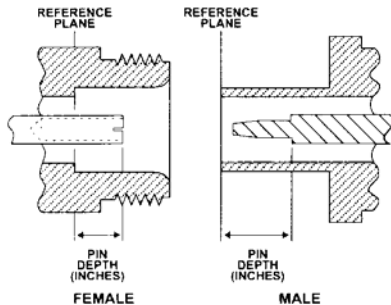

N connector pin depth definition

The center pin of a precision RF component connector has a precision tolerance. The mating connectors of various RF components may not be precision types. Consequently, the center pins of these devices may not have the proper pin depth. The pin depth of DUT connectors should be measured to assure compatibility before attempting to mate them with Power Sensor connectors. An Anritsu Pin Depth Gauge or equivalent can be used for this purpose.



Pin depth gauge

If the measured connector is out of tolerance in the "+" region, the center pin is too long (see Allowable DUT connector pin depth table below). Mating under this condition will likely damage the precision RF component connector. If the test device connector measures out of tolerance in the "-" region, the center pin is too short. This should not cause damage, but it will result in a poor connection and a consequent degradation in performance.

DUT Connector Type	Anritsu Gauging Set Model	Pin Depth (inches)	Pin Depth Gauge Reading
N - Male	01-163	207 -0.000 +0.030	207 +0.000 -0.030
N - Female			
WSMA - Male	01-162	-0.000 -0.010	Same as pin depth
WSMA - Female			
3.5 mm - Male			
3.5 mm - Female			

Allowable DUT connector pin depth

Avoid over torquing connectors

Over torquing connectors is destructive; it may damage the connector center pin. Finger-tight is usually sufficient for Type N connectors. *Always* use a connector torque wrench (8 inch-pounds) when tightening WSMA, K or V type connectors. *Never use pliers to tighten connectors.*

Avoid mechanical shock

Precision connectors are designed to withstand years of normal bench handling. However, do not drop or otherwise treat them roughly. Mechanical shock will significantly reduce their service life.

Do not disturb Teflon tuning washers on connector center pins

The center conductor on many RF component connectors contains a small Teflon washer that is located near the point of mating. This washer compensates for minor impedance discontinuities at the interface. *Do not disturb this washer.* The location of the washer is critical to the performance of the RF component.

Cleaning connectors

The precise geometry that makes possible the RF component's high performance can easily be disturbed by dirt and other contamination adhering to the connector interfaces. When not in use, keep the connectors covered.

To clean the connector interfaces, use a clean cotton swab that has been dampened with denatured alcohol.

Note: Most cotton swabs are too large to fit in the smaller connector types. In these cases, it is necessary to peel off most of the cotton and then twist the remaining cotton tight. Be sure that the remaining cotton does not get stuck in the connector. Cotton swabs of the appropriate size can be purchased through a medical laboratory-type supply center.

The following are some important tips on cleaning connectors:

- Use only denatured alcohol as a cleaning solvent
- Do not use excessive amounts of alcohol as prolonged drying of the connector may be required
- Never put lateral pressure on the center pin of the connector
- If installed, do not disturb the Teflon washer on the center conductor pin
- Verify that no cotton or other foreign material remains in the connector after cleaning it
- If available, use compressed air to remove foreign particles and to dry the connector
- After cleaning, verify that the center pin has not been bent or damaged.

Index

A

AC line power, v, 3-3
accessories, x, D-22
adaptive frequency hopping, viii, 1-3, 10-1
AFH, viii, 1-3, 10-1
AFH – audio testing, viii, 9-8
AFH - configuring MT8852B, viii, 10-6
AFH - installing, viii, 10-6
AFH - processing, viii, 10-4
audio measurements, viii, 1-3, 9-1, 10-9
authentication, vi, 7-8

B

bandwidth filter, vi, 7-14
bit and frame error rates, x, 1-4, E-1
Bluesuite Pro, v, 2-4
Bluetooth, i
Bluetooth 1.2, viii, 10-2
Bluetooth interferer, vii, 7-16

C

carrier & modulation test, vii, 8-37
carrier & modulation test - results, viii, 8-66
carrier drift test - results, viii, 8-56
carrier drift test – single payload, vii, 8-48
carrier drift test - standard, vii, 8-21
channel use vs time - AFH, viii, 10-7
configuration, vi, viii, 1-3, 5-4, 7-1, 10-6
connections, vi, 1-3, 4-1, A-8
connector care, x, 1-4, G-1
continuous wave measurement, vii, 7-18
CW measurement, vii, 7-18

D

data entry, vi, 5-6
declaration of conformity, iv, v
differential phase test, vii, 8-39
differential phase test- results, viii, 8-68

E

EDR, viii, 11-3
EDR BER floor Test, vii, 8-42
EDR BER floor test - results, viii, 8-71
EDR max input Test, vii, 8-44

EDR maximum input level test - results, viii, 8-72
EDR sensitivity test, vii, 8-40
EDR sensitivity test - results, viii, 8-69
entering the BT address of the EUT, viii, 8-52, 9-2
environmental requirements, v, 3-2
errata 1158, vii, 7-3, 7-23, C-1
error codes, ix, A-3, A-8, A-10
EUT - setting up, vi, 7-4
EUT address, vi, 6-3
EUT address – viewing user friendly name, vi, 7-4
EUT connection settings, vii, 8-8
EUT control, vi, 7-6

F

features, v, 2-2
FER vs time - AFH, viii, 10-8
front panel - connectors, vi, 4-2
front panel - controls, vi, 5-2
front panel - layout, vi, 1-3, 5-1
fuses, v, 3-3

G

getting started, vi, 1-3, 6-1
GPIO, x, 2-3, 7-2, 7-11, 7-22, A-3, B-1, C-1, D-21
grounding, v, 3-3
guard interval, ix, 11-3

H

hard and soft keys, vi, 5-4

I

identification number, v, 2-4, 7-8
identity, vi, 7-10
initial carrier test - results, viii, 8-55
initial carrier test – single payload, vii, 8-47
initial carrier test - standard, vii, 8-18
inquiries - setting up, vi, 7-7
inquiry - making, vi, 7-9
inspection and assembly, v, 1-3, 3-1
IQ data output, viii, 1-3, 11-1

L

link timeout, vi, 7-14
locking and unlocking scripts, vii, 8-4

M

- manual - associated documentation, v, 1-4
- manual - purpose and scope, v, 1-2
- manual - your comments, v, 1-2
- maximum input power test - results, viii, 8-63
- maximum input power test – single payload, viii, 8-51
- maximum input power test - standard, vii, 8-33
- modulation index, vi, 7-14
- modulation index test - results, viii, 8-62
- modulation index test – single payload, viii, 8-51
- modulation index test - standard, vii, 8-30
- MT8852B - configuring the, vi, viii, 1-3, 5-4, 7-1, 10-6
- MT8852B - definition, v, 2-2
- MT8852B - features, v, 2-2
- MT8852B - overview, v, 1-3, 2-1
- MT8852B - preparing for use, vi, 6-2
- MT8852B - setting up, vi, 7-10
- multi sensitivity test - results, viii, 8-60
- multi slot sensitivity test - standard, vii, 8-27
- multi-slot sensitivity test – single payload, viii, 8-50

N

- notation conventions, v, 1-4
- null packets mode, vi, 6-6

O

- operating environment, v, 3-4
- operation, ii, iii
- options, v, x, 2-4, D-22
- output power test - results, viii, 8-53
- output power test – single payload, vii, 8-46
- output power test - standard, vii, 8-12

P

- passwords - changing, vii, 8-5
- path offset table, vii, 8-9
- power control test - results, viii, 8-54
- power control test – single payload, vii, 8-46
- power control test - standard, vii, 8-15
- power requirements, v, x, 3-3, D-21
- power-on procedure, vi, 5-4

- preparing for use, vi, 6-2
- preset values, ix, 1-4, 5-4, 6-2, C-1

R

- rack mounting, v, 3-4
- rack mounting – side by side, v, 3-8
- rack mounting - single unit, v, 3-4
- range hold, vi, 7-13
- rear panel - connectors, vi, x, 4-2, D-20
- rear panel outputs, vii, 7-17
- receive path – audio testing, viii, 9-6
- relative TX power test, vii, 8-35
- relative tx power test - results, viii, 8-65
- remote loopback – audio testing, viii, 9-2
- remote power control, vii, 7-21
- RS232, x, 7-3, D-21

S

- safety symbols, ii, v
- screen display, vi, 7-12
- script menu, vii, 1-3, 8-1
- script parameters, vii, 8-7
- shipment - preparation for, v, 3-3
- shipped items, v, 3-2
- signal generator, vi, 7-15
- single payload mode, vi, 6-5
- single payload script mode, vii, 8-46
- single slot sensitivity - results, viii, 8-58
- single slot sensitivity test – single payload, viii, 8-49
- single slot sensitivity test - standard, vii, 8-24
- single test, vi, 6-3
- software release notification, v, 1-2
- software update, vii, 7-22
- software versions, v, 1-2
- sound, vi, 7-12
- specification, viii, ix, 1-4, 2-3, 8-12, 8-18, 8-21, 8-24, 8-27, 8-48, 10-5, A-8, A-9, D-1, D-3, D-4, D-5, D-7, D-8, D-9, D-10, D-11, D-12, D-13, D-14, D-15, D-16
- standard mode, vi, 6-5
- standard script mode, vii, 8-12
- storage - preparation for, v, 3-2
- storage and repackaging, v, 3-2
- support, x, 1-4, F-1, F-2
- supported features, vi, 7-5
- system features, vii, 7-3, 7-20, 7-21, 7-22, 7-23, 10-6
- system interfaces - configuring, vi, 7-11

T

technical support, x, 1-4, F-1, F-2
terminology glossary, ix, 1-4, B-1
test control delay, vii, 8-8
test mode, vi, 6-3
test pause, vii, 8-8, A-5
test results, viii, 8-53
test script - selecting, vi, 6-2
test script operation, vii, 7-19
tests- running, vii, 8-6
top-line messages, ix, 1-3, A-1

trademark acknowledgments, i, v
transmit path – audio testing, viii, 9-5

U

updating the software, vii, 7-22
user friendly name, vi, 7-4

W

warranty, i, v



<p>AUSTRALIA ANRITSU PTY. LTD. Unit 3, 170 Foster Road Mt Waverley, VIC 3149 Australia Telephone: +61-3-9558-8177 Fax: +61-3-9558-8255</p>	<p>Brazil ANRITSU ELETRONICA LTDA. Praia de Botafogo 440, Sala 2401 CEP 22250-040, Rio de Janeiro, RJ, Brasil Telephone: +55-21-5276922 Fax: +55-21-537-1456</p>	<p>CANADA 700 Silver Seven Road, Suite 120, Kanata, ON K2V 1C3, Canada Telephone: +1-613-591-2003 Fax: +1-613-591-1006</p>
<p>CHINA ANRITSU BEIJING SERVICE CENTER 416W Beijing Fortune Building 5 Dong San Huan Bei Lu Chao Yang Qu, Beijing 1000004, China Telephone: +86-1186-1065909237 Fax: +86-1186-1065909236</p>	<p>FINLAND Anritsu AB Piispanportti 9, FIN-02240 Espoo, Finland Telephone: +358-9-435-522-0 Fax: +358-9-435-522-50</p>	<p>FRANCE 9, Avenue du Québec Z.A. de Courtabœuf 91951 Les Ulis Cedex, France Telephone: +33-1-60-92-15-50 Fax: +33-1-64-46-10-65</p>
<p>GERMANY Grafenberger Allee 54-56, 40237 Düsseldorf, Germany Telephone: +49-211-96855-0 Fax: +49-211-96855-55</p>	<p>HONG KONG ANRITSU LIMITED LTD. Suite 719, 7/F., Chinachem Golden Plaza, 77 Mody Road, Tsimshatsui East, Kowloon, Hong Kong, China Telephone: +852-2301-4980 Fax: +852-2301-3545</p>	<p>ITALY ANRITSU Sp.A Via Elio Vittorini, 129, 00144 Roma EUR, Italy Telephone: +39-06-509-9711 Fax: +39-06-502-24-25</p>
<p>JAPAN 5-1-1 Onna, Atsugi-shi, Kanagawa 243-8555 Japan Telephone: +81-46-223-1111 Fax: +81-120-542-425</p>	<p>KOREA ANRITSU CORPORATION LTD. 14F Hyun Juk Bldg. 832-41, Yeoksam-dong, Kangnam-ku, Seoul, Korea Telephone: +82-2-553-6603 Fax: +82-2-553-6604* 5</p>	<p>SINGAPORE 10, Hoe Chiang Road, # 07-01/02 Keppel Towers Singapore 089315 Telephone: +65-282 2400 Fax : +65- 282 2533</p>
<p>SWEDEN Anritsu AB Fågelviksvägen 9A 145 84 Stockholm Sweden Telephone: +46-8-74-05-840 Fax: +46-8-71-09-960</p>	<p>TAIWAN ANRITSU CO., LTD. 7F, NO.316, Sec.1 NeiHu Rd., Taipei, Taiwan, R.O.C Telephone: +886-2-8751-1816 Fax: +886-2-8751-1817</p>	<p>UNITED KINGDOM European Measurement Division Rutherford Close, Stevenage, Herts, SG1 2EF U.K. Telephone: +44-1438-740011 Fax: +44-1438-740202</p>
<p>UNITED STATES 1155 East Collins Blvd., Richardson, TX 75081, U.S.A. Toll Free: 1-800-ANRITSU (267-4878) Telephone: +1-972-644-1777 Fax: +1-972-671-1877</p>		